

# Ball Probe Moisture Meter

With Bluetooth<sup>®</sup>

**Model MR59**



# Table of Contents

---

<b>1. Advisories</b>	<b>3</b>
1.1 Copyright	3
1.2 Quality Assurance	3
1.3 Documentation	3
1.4 Disposal of Electronic Waste	3
<b>2. Introduction</b>	<b>4</b>
2.1 Key Features	4
<b>3. Description</b>	<b>4</b>
3.1 Meter Description	4
3.2 Display Description	5
3.3 Button Description	5
<b>4. Operation</b>	<b>6</b>
4.1 Meter Power, APO, and Zero Calibration	6
4.2 Moisture Measurements	6
4.3 Maximum and Minimum Readings	6
4.4 Data Hold	6
4.5 Display Backlight	6
4.6 Worklight	6
4.7 High Moisture Audible Alarm	7
4.8 Bluetooth® Transmission Basics	7
<b>5. Bluetooth® Technical Details</b>	<b>7</b>
<b>6. Field Firmware Upgrades via USB Interface</b>	<b>8</b>
6.1 System Firmware Upgrade	8
6.2 Bluetooth® Firmware Upgrade	9
<b>7. Maintenance</b>	<b>9</b>
7.1 Cleaning	9
7.2 Battery Installation and Replacement	9
<b>8. Safety</b>	<b>10</b>
8.1 FCC Compliance	10
<b>9. Specifications</b>	<b>10</b>
<b>10. Technical Support</b>	<b>11</b>
<b>11. Three-Year Limited Warranty</b>	<b>11</b>

# 1. Advisories

---

## 1.1 Copyright

© 2018, FLIR Systems, Inc. All rights reserved worldwide. No parts of the software including source code may be reproduced, transmitted, transcribed or translated into any language or computer language in any form or by any means, electronic, magnetic, optical, manual or otherwise, without the prior written permission of FLIR Systems.

The documentation must not, in whole or part, be copied, photocopied, reproduced, translated or transmitted to any electronic medium or machine readable form without prior consent, in writing, from FLIR Systems.

Names and marks appearing on the products herein are either registered trademarks or trademarks of FLIR Systems and/or its subsidiaries. All other trademarks, trade names or company names referenced herein are used for identification only and are the property of their respective owners.

## 1.2 Quality Assurance

The Quality Management System under which these products are developed and manufactured has been certified in accordance with the ISO 9001 standard.

FLIR Systems is committed to a policy of continuous development; therefore, we reserve the right to make changes and improvements on any of the products without prior notice.

## 1.3 Documentation

To access the latest manuals and notifications, go to the 'Downloads' tab at:

<http://support.flir.com>. It only takes a few minutes to register online. In the download area you will also find the latest releases of manuals for our other products, as well as manuals for our historical and obsolete products.

## 1.4 Disposal of Electronic Waste



As with most electronic products, this equipment must be disposed of in an environmentally friendly way, and in accordance with existing regulations for electronic waste.

Please contact your FLIR Systems representative for more details.

## 2. Introduction

---

Thank you for selecting the FLIR MR59 Ball Probe Moisture Meter with Bluetooth®. This instrument detects moisture in wood and other building materials and transmits readings to a remotely paired smart device. This device is shipped fully tested and calibrated and, with proper use, will provide years of reliable service.

### 2.1 Key Features

- Non-invasive pinless moisture measurements for wood and other building materials including plywood, drywall, oriented strand board (OSB), brick, cement screed, concrete, cement mortar, anhydrite screed, lime mortar, and plaster
- Bluetooth® data transmission
- Firmware upgrades via micro USB port located in battery compartment
- Maximum/Minimum readings
- High moisture Alarm audible alert
- LED Worklight
- Backlit LCD
- Data Hold
- Battery powered (1 x 9V battery)
- Automatic Power OFF after 30 minutes

## 3. Description

---

### 3.1 Meter Description

1. Moisture sensor (capacitance type)
2. Backlit LCD
3. Data Hold / MIN-MAX clear button
4. Worklight ON/OFF and up arrow button
5. Backlight ON/OFF and down arrow button
6. Power button
7. Alarm enable/Alarm threshold button
8. Worklight
9. Tripod mount
10. Battery/USB port compartment

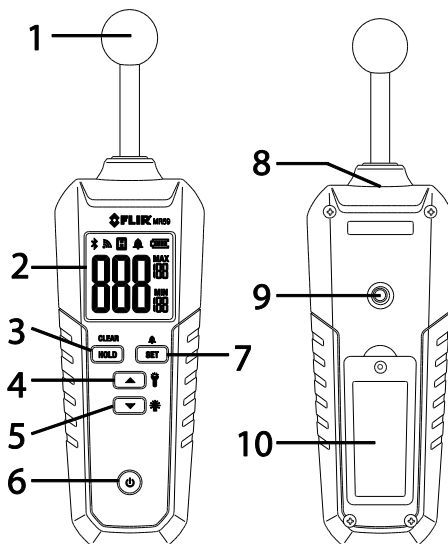





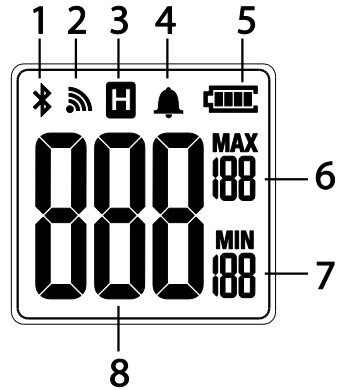

### 3.2 Display Description

1. Bluetooth® (BLE) icon (when paired)
2. Transmission icon (flashes when paired)
3. Data Hold icon
4. Alarm enabled icon
5. Battery status icon
6. Maximum reading
7. Minimum reading
8. Moisture reading



### 3.3 Button Description

	Long press to power the meter ON/OFF
<b>CLEAR</b> <b>HOLD</b>	Long press to clear the MIN/MAX reading memories Short press to enable/disable Data Hold mode
 <b>SET</b>	Long press to enable/disable the audible Alarm Short press to access the alarm threshold (limit) screen
	In the Alarm limit mode, increase the moisture alarm threshold
	In the Alarm limit mode, decrease the moisture alarm threshold
	Long press to switch Worklight ON/OFF
	Long press to the switch display backlight ON/OFF

## 4. Operation

---

### 4.1 Meter Power, APO, and Zero Calibration

1. One (1) 9V battery (rear compartment) powers the meter.
2. Long press the power button  to switch the meter ON/OFF. If the meter display does not switch ON, please check the battery.
3. The meter beeps and flashes **CAL** while it performs a self-test (zero calibration). Keep hands and objects away from the sensor while the meter powers up for optimum calibration accuracy.
4. The meter's APO feature automatically switches the meter OFF after 30 minutes of inactivity.

### 4.2 Moisture Measurements

1. Power the meter, keeping hands and objects away from the ball sensor.
2. Place the sensor against the surface of the material under test. The sensitivity of the sensor is uniform across its entire surface, so you can easily move the sensor in a variety of orientations to make it easier for you to reach and position during tests.
3. View the moisture reading on the LCD. Take a number of readings in a variety of locations for the best representation of the moisture present. Compare readings between a known dry area and an area where you suspect to find moisture.
4. The measurement range is 0 to 100 (relative readings).

### 4.3 Maximum and Minimum Readings

In addition to the real-time moisture reading display, the meter shows the highest (MAX) and lowest (MIN) readings for a measurement session. Long press the **CLEAR** button to reset the MIN/MAX reading memories.

### 4.4 Data Hold

Short press the **HOLD** button to freeze/unfreeze the displayed reading. The 'H' icon appears when the data hold mode is active.



### 4.5 Display Backlight

Long press the backlight button  to switch the LCD backlight ON/OFF. Over use of the backlight will shorten battery life considerably.

### 4.6 Worklight



Long press the Worklight button  to switch the light ON/OFF. To conserve battery life use the light only as needed.

## 4.7 High Moisture Audible Alarm

The MR59 beeps when the moisture reading exceeds the high alarm limit. To set the alarm limit, short press the  **SET** button and use the arrow buttons to set the value. To exit the alarm programming screen, short press the SET button again. To enable/disable the audible alarm, long press the  **SET** button. When the alarm is enabled (default), the alarm bell icon appears. The alarm limit is set to '20' by default.

## 4.8 Bluetooth® Transmission Basics

To connect to a remote device running **FLIR Tools™**, turn on the remote device and start the **FLIR Tools™** application. Open **Instruments**, and search for the MR59 (the MR59 must be ON). Tap to connect to the MR59.



When connected to a remote device, the MR59 displays the Bluetooth®  and the transmission  icons and automatically transmits moisture data.

When you switch the meter ON, the Bluetooth® and transmission icons will be OFF. They appear only when you pair the MR59 with a remote device.

## 5. Bluetooth® Technical Details

---

When connected to a device running the **FLIR Tools™** mobile app, the MR59 (using the **METERLiNK®** protocol) continually sends readings for live display on the remote device. When connected to a compatible FLIR camera that supports **BLE** (Bluetooth® Low Energy), the MR59 continually sends meter readings for live display on the camera screen. Download the **FLIR Tools™** mobile app from the Google Play™ store, the Apple App store, or here: <https://www.flir.com/products/flir-tools-app/>

1. When successful communication between the meter and a remote device or FLIR camera is established, the Bluetooth® icon  and the transmission icon  appear on the meter display.
2. Refer to the **FLIR Tools™** help utility (in the mobile app) for detailed information and tutorials regarding the **FLIR Tools™** application.
3. Refer to Section 4.8 *Bluetooth® Transmission Basics* for using the meter to transmit data via Bluetooth®.

## 6. Field Firmware Upgrades via USB Interface

---

The MR59 includes a micro USB port, located inside the battery compartment. The USB port allows the user to upgrade the System firmware or the Bluetooth® firmware by first downloading an upgrade file from the FLIR website and then connecting the meter to a PC to transfer the file to the meter. Firmware upgrades are available at the <http://support.flir.com> website.

### To update the firmware, you will need:

- Access to the website where the upgrade file(s) are located:  
<http://support.flir.com>
- The MR59 to be updated
- The update file(s). Refer to the steps in the next sections:

### 6.1 System Firmware Upgrade

1. Visit [support.flir.com](http://support.flir.com) to obtain a firmware upgrade file.
2. Select the 'Downloads' tab and then select 'Instrument Firmware' (Test and Measurement) from the drop down menu.
3. Select MR59 from the second drop down menu.
4. Select and download the firmware upgrade file to the PC.
5. With the meter **OFF**, open the battery compartment and **completely disconnect the battery**. Failure to disconnect the battery could cause damage to the PC.
6. Connect the meter to the PC via the micro USB jack located in the battery compartment. When connected, the meter will show the screen below:



7. Copy the firmware upgrade file to the MR59 drive.
8. Disconnect the USB cable from the PC USB port and from the meter's USB port in the battery compartment.
9. Connect the battery to the meter and secure the battery compartment.
10. Turn the meter ON.
11. If the battery power is sufficient, the upgrade will begin automatically and the meter will display the screen shown below:



12. If the battery power is too low, the meter will display the 'LO' message shown below. You must replace the battery before you can upgrade the meter firmware.





13. When the upgrade is complete, the meter will return to the normal operating mode.

## 6.2 Bluetooth® Firmware Upgrade

To execute a Bluetooth® Firmware Upgrade please perform the same steps as listed in Section 6.1, *System Firmware Upgrade*, above. If there is an error, the 'Err' icon will flash and the meter will return to the normal operation mode. If this error occurs, please repeat the upgrade procedure. If the problem persists, contact FLIR technical support.



# 7. Maintenance

---

## 7.1 Cleaning

- Wipe meter and sensor with a water-dampened cloth as needed. Do not use solvents or abrasives.
- Always keep the instrument dry.
- Prevent dirt from accumulating on the sensor.

## 7.2 Battery Installation and Replacement

If the instrument does not switch ON or if the battery status icon indicates a low battery voltage, please replace the battery:

1. Remove the Phillips head screw at the rear of the instrument and remove the battery compartment cover.
2. Install or replace the 9V battery observing correct polarity.
3. Secure the battery compartment before operating the meter.

## 8. Safety

---

- Handle the meter carefully and do not subject the sensor to shock or excessive vibration.
- Keep the instrument dry.
- Pack the battery separately when the meter is to be stored for periods longer than 60 days.
- Do not use this device for purposes other than those described in this manual.

### 8.1 FCC Compliance

This device complies with part 15 of the FCC Rules. Operation is subject to the following two conditions:

1. This device may not cause harmful interference.
2. This device must accept any interference received, including interference that may cause undesired operation.

This equipment has been tested and found to comply with the limits for a Class B digital device, pursuant to part 15 of the FCC Rules. These limits are designed to provide reasonable protection against harmful interference in a residential installation. This equipment generates, uses, and can radiate radio frequency energy and, if not installed and used in accordance with the instructions, may cause harmful interference to radio communications. However, there is no guarantee that interference will not occur in a particular installation. If this equipment does cause harmful interference to radio or television reception, which can be determined by turning the equipment off and on, the user is encouraged to try to correct the interference by one or more of the following measures:

1. Reorient or relocate the receiving antenna.
2. Increase the separation between the equipment and receiver.
3. Connect the equipment into an outlet on a circuit different from that to which the receiver is connected.
4. Consult the dealer or an experienced radio/TV technician for help.

#### **WARNING**

Changes or modifications not expressly approved by the party responsible for compliance could void the user's authority to operate the equipment.

## 9. Specifications

---

Measurement range	Moisture, 0 to 100
Measurement accuracy	Relative measurements only
Measurement type	Capacitance ball sensor (non-invasive)
Measurement detection depth	Sensing depth for most common building materials up to 4.0" (100mm), this may vary depending upon material under test.
Response time	0.5 seconds
Display	Backlit, multifunction LCD
Worklight	High intensity white LED
Auto Power OFF (APO)	After 30 minutes
Power supply	9V battery (rear compartment)

Low battery indicator	 (100% to empty)
Operating RH/Temperature	90%, 32~86°F (0~30°C) 75%, 86~104°F (30~40°C) 45%, 104~122°F (40~50°C)
Housing material	Impact resistant plastic
Drop-proof	6.6 ft. (2m)
IP rating	IP40
Safety Compliance	CE, RCM
Dimensions	9.5 x 2.6 x 1.5 in. (240.5 x 67 x 38mm)
Weight	86 oz. (245g)

## 10. Technical Support

---

Main Website	<a href="http://www.flir.com/test">http://www.flir.com/test</a>
Technical Support Website	<a href="http://support.flir.com">http://support.flir.com</a>
Technical support Email	<a href="mailto:TMSupport@flir.com">TMSupport@flir.com</a>
Service/Repair Support Email	<a href="mailto:Repair@flir.com">Repair@flir.com</a>
Support Telephone number	+1 855-499-3662 option 3 (toll-free)

## 11. Three-Year Limited Warranty

---

This product is protected by FLIR's 3-Year Limited Warranty. Visit [www.flir.com/testwarranty](http://www.flir.com/testwarranty) to read the 3-Year Limited Warranty document. Register your product at the website to receive a free 1-year warranty extension.



---

Corporate Headquarters  
FLIR Systems, Inc.  
2770 SW Parkway Avenue  
Wilsonville, OR 97070  
USA  
Telephone: +1 503-498-3547

Customer Support  
Technical Support Website  
Technical Support Email  
Service and Repair Email  
Customer Support Telephone

<http://support.flir.com>  
[TMSupport@flir.com](mailto:TMSupport@flir.com)  
[Repair@flir.com](mailto:Repair@flir.com)  
+1 855-499-3662 option 3 (toll free)

Publication Identification No.: MR59-en-US  
Release Version: AB  
Release Date: August 2018  
Language: en-US