

TETRIS[®] high-impedance active probes

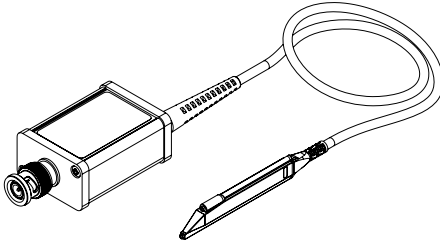

TA112 TETRIS[®] 1000

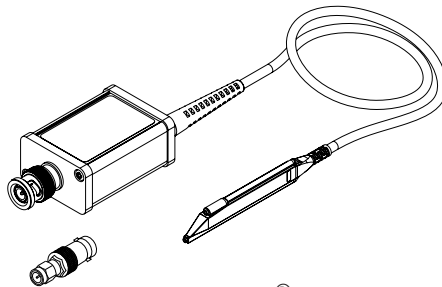

TA222 TETRIS[®] 1500

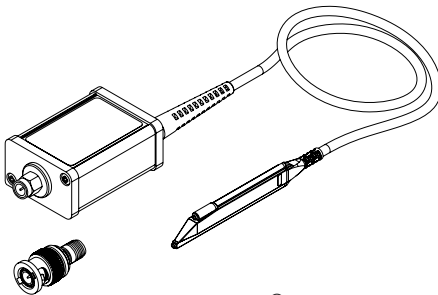

TA223 TETRIS[®] 2500

User's Guide

1. Safety

To prevent possible electrical shock, fire, personal injury, or damage to the product, carefully read this safety information before attempting to install or use the product. In addition, follow all generally accepted safety practices and procedures for working with and near electricity.

The product has been designed and tested in accordance with the European standard publication EN 61010-1:2010, and left the factory in a safe condition.

The following safety descriptions are found throughout this guide:

A **WARNING** identifies conditions or practices that could result in injury or death.

A **CAUTION** identifies conditions or practices that could result in damage to the product or equipment to which it is connected.

Symbols

These safety and electrical symbols may appear on the product or in this guide:

Symbol	Description
	Direct current
	Earth (ground) terminal
	Possibility of electric shock
	Caution. Appearance on the product indicates a need to read these safety and operation instructions.
	Do not dispose of this product as unsorted municipal waste

WARNING To prevent injury or death only qualified personnel should use this product, only as instructed and with only accessories supplied or recommended. Protection provided by the product may be impaired if used in a manner not specified by the manufacturer.

Maximum input ranges

TETRIS probes are protected against accidental electrostatic discharge. The table and frequency derating plot below indicate the full-scale measurement range and overvoltage protection range for the TETRIS probes. The full-scale measurement ranges are the maximum voltages that can be accurately measured by the instrument. The overvoltage protection ranges are the maximum voltages that will not damage the instrument.

WARNING TETRIS probes are **not** designed to measure hazardous live signals as defined by EN 61010. To prevent electric shock, do not connect the probe to voltages exceeding the levels below and do take all necessary safety precautions when working on equipment where hazardous live voltages may be present.

Signal voltage limits of EN 61010		
±70 V DC	33 V AC RMS	±46.7 V pk max.

CAUTION To prevent measurement error or damage to the probe or other connected equipment, do not attempt to measure voltages outside the specified full-scale measurement range or overvoltage protection range below.

Model	Full-scale measurement range	Overvoltage protection (voltage that will not damage)
TETRIS 1000	±8 V (DC + AC peak)	±20 V (DC + AC peak)
TETRIS 1500		
TETRIS 2500		

Grounding

WARNING Never connect the ground input to, or allow it to touch, any electrical potential other than ground. To prevent personal injury or death, use a voltmeter to check that there is no significant AC or DC voltage between the probe ground and the point to which you intend to connect it.

CAUTION Applying a voltage to the ground input is likely to cause permanent damage to the probe or other connected equipment.

External connections

WARNING To prevent injury or death, only use the power cord and adaptor supplied with the product. These are approved for the voltage and plug configuration in your country.

CAUTION Take care to avoid mechanical stress or tight bends on the coaxial cable connecting the probe head to its base. Mishandling could degrade performance and measurement accuracy.

Environment

WARNING To prevent injury or death, do not use near explosive gas or vapor.

CAUTION To prevent damage to the probe, do not use in wet or damp conditions and always use and store your probe in appropriate environments.

	Storage	Operating
Temperature	-40 °C to +70 °C	0 °C to +45 °C
Max. humidity (non-condensing)	80 %	80 % to +30 °C, decreasing linearly to 40 % at +45 °C
Max. altitude	15 000 m	2000 m
Pollution degree	2	

Care of the product

The product contains no user-serviceable parts. Repair, servicing and calibration require specialized test equipment and must only be performed by Pico Technology or an approved service provider. There may be a charge for these services unless covered by the Pico two-year warranty.

WARNING To prevent injury or death, do not use the product if it appears to be damaged in any way, and stop use immediately if you are concerned by any abnormal behavior.

CAUTION To prevent damage, when cleaning the product, use a soft cloth and a solution of mild soap or detergent in water. Do not allow liquids to enter the probe casings and ensure completely dry before use.

2. Accessories included

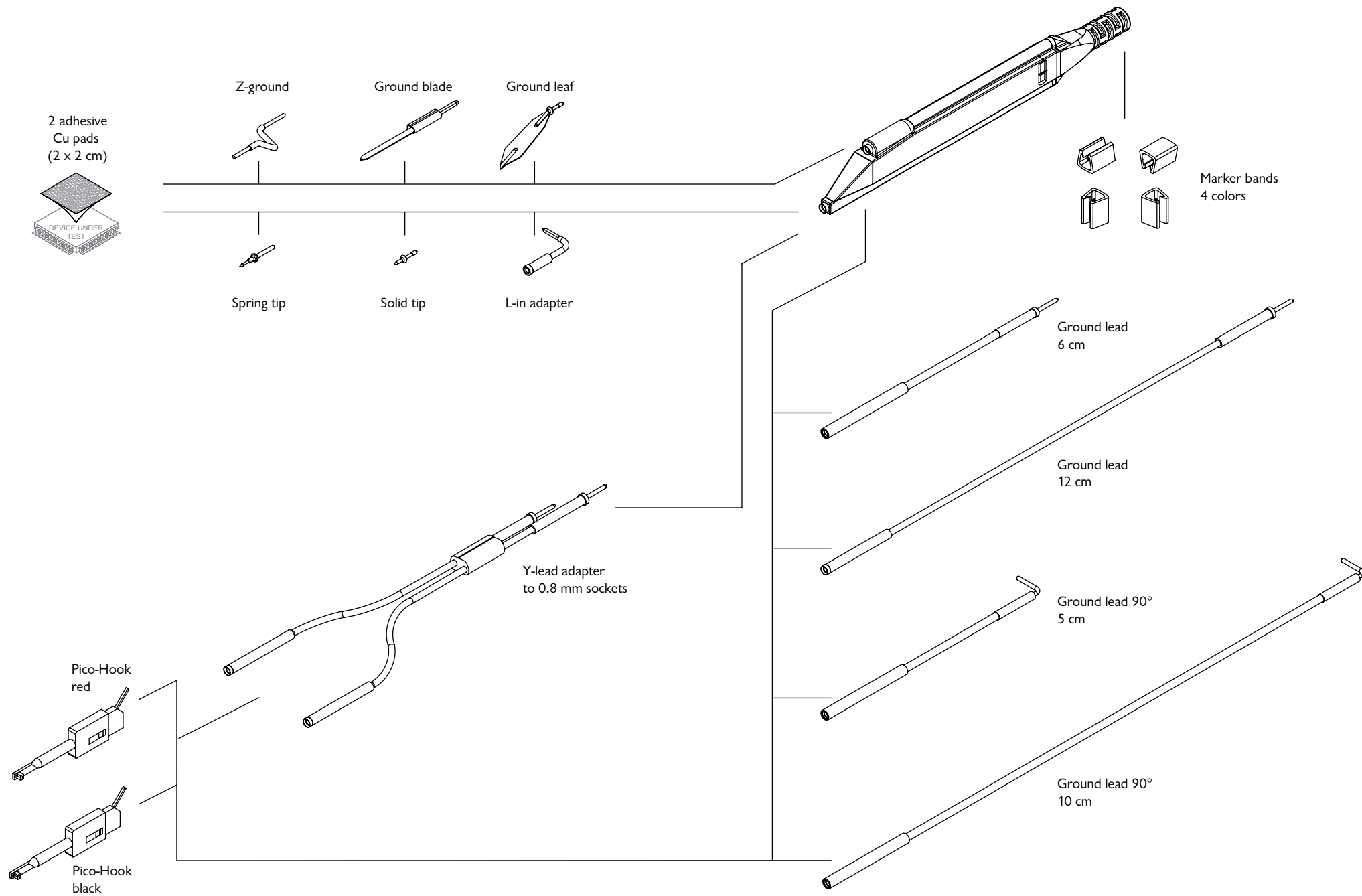

3. About the TETRIS® active probe system

Pico Technology presents a unique inline probing system: the TETRIS® active probe. The unique design of the TETRIS active probe allows contact with adjacent pins on 2.54 mm (0.1 inch) pitch. This is possible due to the probe's narrow housing that allows many of them to be positioned next to each other, permitting multiple pins to be probed at the same time.

TETRIS is independent of any particular system, and with its standard SMA and BNC connectors it can be plugged into any measuring instrument with a 50 Ω input.

With an input resistance of 1 MΩ and an input capacitance of 0.9 pF, the TETRIS probe is suitable for measurements in all frequency ranges. Unlike passive probes, the TETRIS active probe offers a high input impedance into the gigahertz range.

The TETRIS active probe with its high input resistance and low input capacitance is the ideal probe for your everyday measurements.

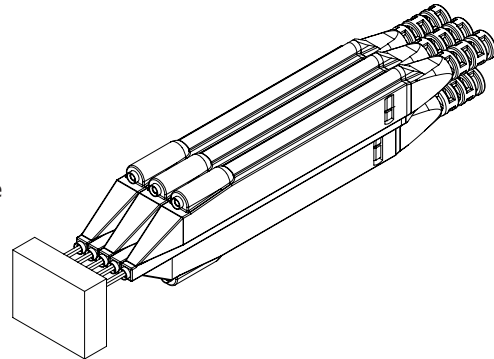

TETRIS® 2500 testing adjacent pins on 2.54 mm pitch

4. Operating basics

When using this active probe device make sure the measuring instrument is set to 50 Ω input coupling and the probe is connected to the power supply.

Note: If the measuring instrument does not have 50 Ω coupling, an external 50 Ω terminator (such as a TA051) can be used, but the useful system bandwidth may be significantly reduced and pulse distortion worsened. Problems typically arise above around 200 MHz (below 1.7 ns transition time).

5. Specifications

Specifications are typical and are published as general information for the user. The instrument should have warmed up for at least 20 minutes before use, and the environmental conditions should not exceed the probe's specified limits.

Specifications are subject to change without notice.

Electrical specifications

Attenuation ratio		10:1 ± 0.5 % at DC
Bandwidth (-3 dB)	TETRIS 1000	1.0 GHz
	TETRIS 1500	1.5 GHz
	TETRIS 2500	2.5 GHz

Maximum input voltage and dynamic measuring range

The maximum input voltage rating of the probe decreases as the frequency of the applied signal increases:

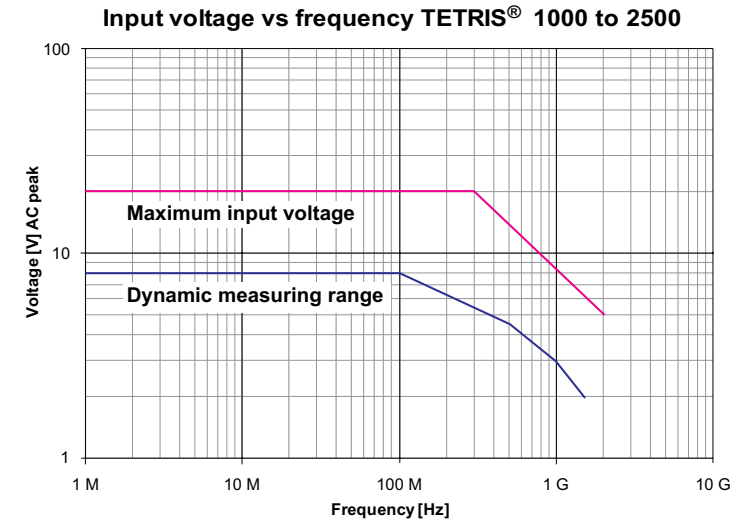

Input resistance (system)	> 1 MΩ
Input capacitance (system)	0.9 pF (typical)
Oscilloscope input coupling	50 Ω AC / DC

The input impedance of the probe decreases as the frequency of the applied signal increases:

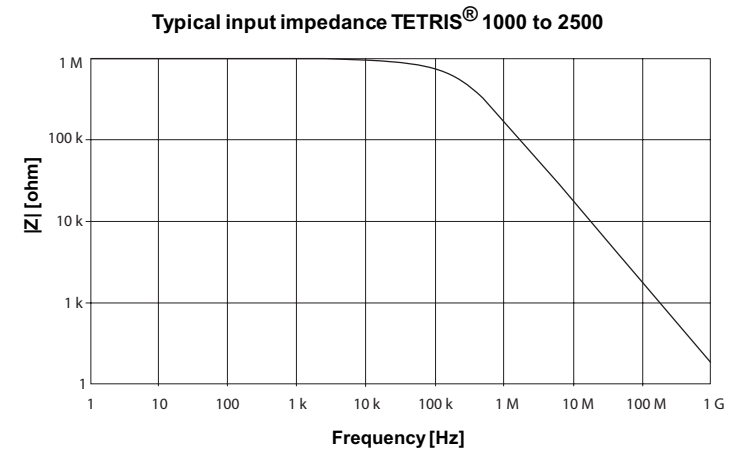

Mechanical characteristics

Weight (probe only)	96 g
Cable length	1.3 m

Manufacturer

PMK Mess- und Kommunikationstechnik GmbH
Königsteiner Str. 98
D-65812 Bad Soden am Taunus
Germany

Sales and support

Pico Technology
James House
Colmworth Business Park
St. Neots PE19 8YP
United Kingdom

Warranty

Pico Technology warrants this oscilloscope accessory for normal use and operation within specifications for a period of two years from date of shipment and will repair or replace any defective product which was not damaged by negligence, misuse, improper installation, accident or unauthorized repair or modification by the buyer. This warranty is applicable only to defects due to material or workmanship. Pico Technology disclaims any other implied warranties of merchantability or fitness for a particular purpose. Pico Technology will not be liable for any indirect, special, incidental, or consequential damages (including damages for loss of profits, loss of business, loss of use or data, interruption of business and the like), even if Pico Technology has been advised of the possibility of such damages arising from any defect or error in this manual or product.

EC declaration of conformity

The manufacturer declares that the following products comply with the requirements of the specified Directives and Standards as listed below. Products carry the CE mark.

Products covered by this declaration:

TA112	TETRIS 1000 1 GHz high-impedance active probe
TA222	TETRIS 1500 1.5 GHz high-impedance active probe
TA223	TETRIS 2500 2.5 GHz high-impedance active probe

EU Directives covered by this declaration:

2004/108/EC	<i>Electromagnetic Compatibility Directive</i>
2006/95/EC	<i>Low Voltage Equipment Directive</i>
2002/96/EC	<i>Waste Electrical and Electronic Equipment</i>
2002/95/EC	<i>Restriction of use of certain Hazardous Substances</i>

The basis on which conformity is being declared:

EN61010-1:2010	<i>Safety requirements for electrical equipment for measurement, control and laboratory use, general equipment requirements.</i>
EN61010-031:2002 + A1:2008	<i>Safety requirements for hand-held probe assemblies for electrical measurement and test.</i>
EN61326-1:2006	<i>Electrical equipment for measurement, control and laboratory use – EMC requirements. Group 1, Class A equipment – (emissions only).</i>
EN61326-1:2006	<i>Electrical equipment for measurement, control and laboratory use – EMC requirements. Basic Immunity – (immunity only).</i>
RoHS and WEEE	<i>Manufacturer's analysis of the raw materials used in the manufacture of the above products.</i>



Your help and efforts are required to protect and keep our environment clean. Therefore either return this product at the end of life to the manufacturer or ensure WEEE compliant collection and treatment yourself. Do not dispose of as unsorted municipal waste.

Information in this publication supersedes that in all previously published material.

Pico Technology is a registered trade mark of Pico Technology Ltd.

Tetris is a registered trade mark of PMK Mess- und Kommunikationstechnik GmbH.

Copyright © 2015 Pico Technology Ltd. All rights reserved.