

R&S[®]NPA

Power Analyzers

User Manual



1179166402
Version 03

ROHDE & SCHWARZ
Make ideas real



This document describes the following models:

- R&S NPA101 Power Meter (3657.0562.02)
- R&S NPA501 Power Analyzer (3657.0562.03)
- R&S NPA501-G Power Analyzer (3657.0562.05)
- R&S NPA701 Compliance Tester (3657.0562.04)
- R&S NPA701-G Compliance Tester (3657.0562.06)

This manual describes firmware version FW V01.00x and later for the instruments of the R&S®NPA power analyzers.

© 2024 Rohde & Schwarz

Muehldorfstr. 15, 81671 Muenchen, Germany

Phone: +49 89 41 29 - 0

Email: info@rohde-schwarz.com

Internet: www.rohde-schwarz.com

Subject to change – data without tolerance limits is not binding.

R&S® is a registered trademark of Rohde & Schwarz GmbH & Co. KG.

All other trademarks are the properties of their respective owners.

1179.1664.02 | Version 03 | R&S®NPA

Throughout this document, R&S® is indicated as R&S.

Contents

1	Safety and regulatory information.....	9
1.1	Safety instructions.....	10
1.2	Labels on the R&S NPA power analyzers.....	13
1.3	Warning messages in the documentation.....	13
1.4	Where to find key documents on Rohde & Schwarz.....	14
1.5	Korea certification class A.....	14
2	Welcome.....	15
2.1	Key features.....	15
2.2	Documentation overview.....	15
2.2.1	Getting started manual.....	15
2.2.2	User manual.....	16
2.2.3	Tutorials.....	16
2.2.4	Service manual.....	16
2.2.5	Instrument security procedures.....	16
2.2.6	Printed safety instructions.....	16
2.2.7	Specifications and product brochures.....	16
2.2.8	Calibration certificate.....	17
2.2.9	Release notes and open source acknowledgment (OSA).....	17
2.2.10	Application notes, application cards, white papers, etc.....	17
2.2.11	Remote control driver.....	17
3	Getting started.....	18
3.1	Preparing for use.....	18
3.1.1	Lifting and carrying.....	18
3.1.2	Unpacking and checking.....	18
3.1.3	Choosing the operating site.....	18
3.1.4	Setting up the product.....	19
3.1.4.1	Placing the product on a bench top.....	19
3.1.4.2	Mounting the product in a rack.....	20
3.1.5	Considerations for test setup.....	21
3.1.6	Preparing for mains voltage.....	21
3.1.6.1	Preparing for 115 V.....	22

3.1.6.2	Reverting to 230 V.....	23
3.1.7	Connecting to power.....	23
3.1.8	Connecting to LAN.....	24
3.1.9	Connecting USB devices.....	26
3.1.10	Connecting a device under test (DUT).....	26
3.1.11	Switching on or off.....	28
3.1.12	Configuring the initial instrument settings.....	29
3.2	Instrument tour.....	30
3.2.1	Front view.....	30
3.2.1.1	Display.....	31
3.2.1.2	Keys.....	32
	Interactive softkeys.....	32
	System and function keys.....	32
	Navigation controls.....	33
	POWER On/Standby key.....	33
3.2.1.3	Connectors.....	33
3.2.2	Rear view.....	34
3.2.2.1	Connectors.....	35
3.3	Trying out the instrument.....	37
3.4	Instrument control.....	40
3.4.1	Ways to operate the instrument.....	40
3.4.2	Means of manual interaction.....	40
3.4.2.1	Understanding the display information.....	41
3.4.2.2	Accessing the functionality.....	42
3.4.2.3	Accessing menus and dialogs.....	44
3.4.2.4	Entering data.....	44
	Entering numeric parameters.....	44
	Entering alphanumeric data.....	45
3.4.3	Remote control.....	45
4	Measurement setups.....	47
4.1	Voltage-based measurement.....	49
4.2	Current-based measurement.....	50
4.3	Connecting a DUT directly.....	51

4.4	Connecting an external AC/DC shunt or clamp-on current probe.....	52
5	Measurement parameters and ranges.....	54
5.1	Measurement parameters.....	54
5.2	Measurement ranges.....	55
6	Data acquisition.....	58
6.1	Data acquisition settings.....	64
6.2	Voltage settings.....	65
6.3	Current settings.....	67
6.4	Acquisition mode settings.....	68
6.5	Peak hold settings.....	70
6.6	Refresh settings.....	71
7	Measurement modes.....	72
7.1	Integrator.....	72
7.2	Data logging.....	80
7.2.1	Data logging settings.....	85
7.2.2	Storage settings.....	88
7.2.3	File format settings.....	89
7.2.4	Evaluating logged data.....	89
7.3	Limit.....	91
7.4	Standards.....	95
7.5	Measuring power consumption with the R&S NPA701.....	98
8	Display modes.....	107
8.1	Numeric view.....	108
8.2	Harmonics view.....	110
8.3	Waveform view.....	114
8.4	Trendchart view.....	116
8.5	Inrush view.....	119
8.6	Evaluating inrush data.....	125
9	External measurement modes.....	127
9.1	Analog input and output settings.....	128
9.2	Digital input and output settings.....	130
9.3	Sensor settings.....	132

9.4	Measuring with an external probe or shunt.....	134
10	File and data management.....	139
10.1	Save/recall instrument states.....	139
10.2	Screenshot.....	142
11	General instrument settings.....	146
11.1	Update (firmware).....	146
11.2	Interface.....	149
11.3	Miscellaneous.....	149
11.3.1	Device information.....	149
11.3.2	Date and time.....	151
11.3.3	Sound.....	151
11.3.4	Display settings.....	152
11.3.5	Key brightness.....	154
11.3.6	Device name.....	156
11.3.7	CSV.....	157
11.3.7.1	About CSV.....	158
11.3.7.2	CSV settings.....	158
11.4	Power up.....	160
11.5	Default.....	161
12	Network operation and remote control.....	162
12.1	Remote control interfaces and protocols.....	162
12.1.1	LAN interface.....	164
12.1.1.1	VISA resource strings.....	164
12.1.2	USB interface.....	165
12.1.3	GPIB interface (IEC/IEEE bus interface).....	166
12.1.4	Status reporting system.....	167
12.1.4.1	Overview of the R&S NPA status registers.....	168
12.1.4.2	Instrument-specific status questionable register.....	168
12.1.4.3	Instrument-specific status operation register.....	169
12.2	Remote access settings.....	170
12.2.1	USB settings.....	171
12.2.2	Ethernet settings.....	172

12.2.3	GPIB settings.....	175
12.3	Connecting the R&S NPA for remote access.....	176
12.3.1	Connecting to LAN.....	176
12.3.2	Connecting the R&S NPA to the USB interface.....	176
12.3.3	Connecting the R&S NPA to the IEC 625/IEEE 488 interface.....	177
12.4	Adjusting the interface addresses.....	177
12.4.1	How to configure the Ethernet settings.....	177
12.4.2	How to change the GPIB address.....	180
12.4.3	How to configure the USB connection.....	181
12.5	Starting and stopping remote control.....	182
13	Remote control commands.....	184
13.1	Conventions used in SCPI command descriptions.....	184
13.2	Common commands.....	185
13.3	CHANnel:ACQuisition subsystem.....	188
13.4	CHANnel:EXTernal subsystem.....	197
13.5	CHANnel:LIMit subsystem.....	206
13.6	CHANnel:MEASurement subsystem.....	209
13.7	CHANnel:NAME subsystem.....	213
13.8	DATA subsystem.....	213
13.9	DISPlay subsystem.....	216
13.10	HardCOPy Subsystem.....	217
13.11	INTegrator subsystem.....	218
13.12	LOG subsystem.....	223
13.13	STATus subsystem.....	227
13.13.1	Status operation register.....	228
13.13.2	Status questionable register.....	229
13.14	SYSTem subsystem.....	230
13.15	VIEW subsystem.....	236
13.15.1	Display mode commands.....	240
13.15.2	Inrush acquisition commands.....	246
14	Troubleshooting and notifications.....	248
14.1	Displaying status information and notifications.....	248
14.2	Problems during firmware update.....	248

14.3	Problems with remote control over LAN.....	249
14.3.1	Cannot establish a LAN connection.....	249
14.3.2	Cannot communicate over LAN.....	249
14.4	Contacting customer support.....	249
15	Transporting.....	251
16	Maintenance, storage and disposal.....	252
16.1	Cleaning.....	252
16.2	Changing fuses.....	252
16.3	Storage.....	252
16.4	Disposal.....	252
	Glossary: List of often used terms and abbreviations.....	254
	List of commands.....	257
	Index.....	260

1 Safety and regulatory information

The product documentation helps you use the product safely and efficiently. Follow the instructions provided here and in the following chapters.

Intended use

The R&S NPA power analyzers are used to measure and analyze AC/DC load and standby current characteristics, e.g. for measuring inrush currents or compliance testing. It is designed for industrial use, e.g. production testing, maintenance and engineering labs.

The test adapter R&S NPA-Zx is an accessory for the R&S NPA power analyzers. It can be used to analyze the performance of the mains with the DUT connected. The test adapter is available with several country-specific outlets. The AC/DC clamp-on current probes R&S HZC50 and R&S HZC51 provide extended power measurement range.

Use the product and its accessories only for their designated purpose. Observe the operating conditions and performance limits stated in the specification document, also called data sheet.

Target audience

Only connect, set up and use a power analyzers if you are an electrically skilled person. Such persons have the education and experience needed to recognize risks and to avoid hazards of working with electricity.

This document provides information throughout the life cycle of the product for installers, operators, technicians, maintenance and service personnel.

Follow the safety instructions provided in [Chapter 1.1, "Safety instructions"](#), on page 10 and the additional information provided during setup or operation procedures.

Where do I find safety information?

Safety information is part of the product documentation. It warns you of potential dangers and gives instructions on how to prevent personal injury or damage caused by dangerous situations. Safety information is provided as follows:

- In [Chapter 1.1, "Safety instructions"](#), on page 10. The same information is provided in many languages in printed format. The printed "Safety Instructions" for "Power Supplies and Power Analyzers" (document number 1171.2055.99) are delivered with the product.
- Throughout the documentation, safety instructions are provided when you need to take care during setup or operation.

1.1 Safety instructions

Products from the Rohde & Schwarz group of companies are manufactured according to the highest technical standards. To use the products safely, follow the instructions provided here and in the product documentation. Keep the product documentation nearby and offer it to other users.

Use the product only for its intended use and within its performance limits. Intended use and limits are described in the product documentation such as the data sheet, manuals and the printed "Safety Instructions". If you are unsure about the appropriate use, contact Rohde & Schwarz customer service.

Only people skilled in electrical work should connect, set up and use the product. Such persons have the education and experience needed to recognize risks and avoid hazards of working with electricity. These users also need sound knowledge of at least one of the languages in which the user interfaces and the product documentation are available.

Reconfigure or adjust the product only as described in the product documentation or the data sheet. Any other modifications can affect safety and are not permitted.

Never open the casing of the product. Only service personnel authorized by Rohde & Schwarz are allowed to repair the product. If any part of the product is damaged or broken, stop using the product. Contact Rohde & Schwarz customer service at <https://www.rohde-schwarz.com/support>.

Lifting and carrying the product

Look up the maximum weight in the data sheet. A single person can only carry a maximum of 18 kg safely depending on age, gender and physical condition. If your product is heavier than 18 kg, do not move or carry it by yourself.

To move the product safely, you can use lifting or transporting equipment such as lift trucks and forklifts. Follow the instructions provided by the equipment manufacturer.

Choosing the operating site

Only use the product indoors. The product casing is not waterproof. Water that enters can electrically connect the casing to live parts, which can lead to electric shock, serious personal injury or death if you touch the casing.

Unless otherwise specified, you can operate the product up to an altitude of 2000 m above sea level. The product is suitable for pollution degree 2 environments where nonconductive contamination can occur. For more information on environmental conditions such as ambient temperature and humidity, see the data sheet.

Setting up the product

Always place the product on a stable, flat and level surface with the bottom of the product facing down. If the product is designed for different positions, secure the product so that it cannot fall over.

If the product has foldable feet, always fold the feet completely in or out to ensure stability. The feet can collapse if they are not folded out completely or if the product is

moved without lifting it. The foldable feet are designed to carry the weight of the product, but not an extra load.

If stacking is possible, keep in mind that a stack of products can fall over and cause injury.

If you mount products in a rack, ensure that the rack has sufficient load capacity and stability. Observe the specifications of the rack manufacturer. Always install the products from the bottom shelf to the top shelf so that the rack stands securely. Secure the product so that it cannot fall off the rack.

Connecting to power

The product is an overvoltage category II product. Connect the product to a fixed installation used to supply energy-consuming equipment such as household appliances and similar loads. Keep in mind that electrically powered products have risks, such as electric shock, fire, personal injury or even death. Replace parts that are relevant to safety only by original parts, e.g. power cables or fuses.

Take the following measures for your safety:

- Before switching on the product, ensure that the voltage and frequency indicated on the product match the available power source. If the power adapter does not adjust automatically, set the correct value and check the rating of the fuse.
- If a product has an exchangeable fuse, its type and characteristics are indicated next to the fuse holder. Before changing the fuse, switch off the product and disconnect it from the power source. How to change the fuse is described in the product documentation.
- Only use the power cable delivered with the product. It complies with country-specific safety requirements. Only insert the plug into an outlet with protective conductor terminal.
- Only use intact cables and route them carefully so that they cannot be damaged. Check the power cables regularly to ensure that they are undamaged. Also ensure that nobody can trip over loose cables.
- Only connect the product to a power source with the safety fuse specified in the data sheet.
- Ensure that you can disconnect the product from the power source at any time. Pull the power plug to disconnect the product. The power plug must be easily accessible. If the product is integrated into a system that does not meet these requirements, provide an easily accessible circuit breaker at the system level.

Working with hazardous voltages

Voltages higher than 30 V RMS, or 42 V peak, or 60 V DC are regarded as hazardous contact voltages. Direct contact with them can cause serious injuries.

When working with hazardous contact voltages, use protective measures to preclude direct contact with the measurement setup:

- Before each measurement, inspect all components for damage and replace them if necessary.
- Do not touch exposed connections and components when power is applied.

- Casing, chassis and all measuring terminals are connected to a grounding connection. Never disconnect a grounding connection on the product.
- Switch off the power before connecting or disconnecting the terminal block to the rear panel connector. Tighten all wires connected to the terminal block.
- Only use the wires and terminal blocks delivered with the product.
- Only use insulated wires, not stripped wires, for the terminal connections.
- Turn the mains switch off when the product is not in use.
- When operating measuring accessories, only use the cables delivered with the accessory. If you have to use cables from other manufacturers, make sure that they are of the required overvoltage category.

Do not operate the product in series or parallel unless that setup is supported. If accessories are provided for a product, only use them for that product. See the data sheet.

In series or parallel setups, protect yourself against electric shock before connecting access ports such as the Ethernet port or the USB port using one of the following measures:

- Ensure that all products are grounded by connecting them to the AC power.
- Disconnect all power connections to the product, including outputs.

Measurement categories

IEC 61010-2-030 defines measurement categories that rate products on their ability to resist short transient overvoltages that occur in addition to the working voltage.



This product is designed for measuring within measurement category 0 only. Measurements in this category are performed on circuits not directly connected to mains, such as electronics, battery powered circuits, and specially protected secondary circuits. This measurement category is also known as CAT I.



Cleaning the product

Use a dry, lint-free cloth to clean the product. When cleaning, keep in mind that the casing is not waterproof. Do not use liquid cleaning agents.

Meaning of safety labels

Safety labels on the product warn against potential hazards.

	<p>Potential hazard</p> <p>Read the product documentation to avoid personal injury or product damage.</p>
	<p>Electrical hazard</p> <p>Indicates live parts. Risk of electric shock, fire, personal injury or even death.</p>





	Hot surface Do not touch. Risk of skin burns. Risk of fire.
	Protective conductor terminal Connect this terminal to a grounded external conductor or to protective ground. This connection protects you against electric shock if an electric problem occurs.

1.2 Labels on the R&S NPA power analyzers

Labels on the casing inform about:

- Personal safety, see ["Meaning of safety labels"](#) on page 12.
- Product and environment safety, see [Table 1-1](#).
- Identification of the product, see the serial number on the [rear panel](#).

Table 1-1: Labels regarding the R&S NPA power analyzers and environment safety

	Labeling in line with EN 50419 for disposal of electrical and electronic equipment after the product has come to the end of its service life. For more information, see "Disposing of electrical and electronic equipment" on page 252.
	Grounding terminal (earth ground contact)
	Chassis grounding terminal
	ON (supply voltage)
	OFF (supply voltage)

1.3 Warning messages in the documentation

A warning message points out a risk or danger that you need to be aware of. The signal word indicates the severity of the safety hazard and how likely it will occur if you do not follow the safety precautions.

DANGER

Imminently hazardous situation. Will result in death or serious injury if not avoided.

WARNING

Potentially hazardous situation. Could result in death or serious injury if not avoided.

CAUTION

Potentially hazardous situation. Could result in minor or moderate injury if not avoided.

NOTICE

Potential risks of damage. Could result in damage to the supported product or to other property.

1.4 Where to find key documents on Rohde & Schwarz

Certificates issued to Rohde & Schwarz that are relevant for your country are provided at www.rohde-schwarz.com/key-documents, e.g. concerning:

- Quality management
- Environmental management
- Information security management
- Accreditations

1.5 Korea certification class A



이 기기는 업무용(A급) 전자파 적합기기로서 판매자 또는 사용자는 이 점을 주의하시기 바라며, 가정외의 지역에서 사용하는 것을 목적으로 합니다.

2 Welcome

The R&S NPA power analyzers are compact instruments for measuring AC/DC load and standby current characteristics. Offering a numerical and graphical display, and numerous measurement and mathematical functions, a R&S NPA enables you to measure and analyze power without additional equipment such as computers or a remote environment.

2.1 Key features

The R&S NPA power analyzers set standards in power analyzing. Outstanding key features are:

- Graphical display up to the 50th harmonic on the logarithmic scale
- Configurable dual-channel trend chart function
- Simultaneous display of current and voltage
- High basic measurement accuracy
- Up to 26 definable measurement and mathematical functions
- Adjustable filter system
- Clearly represented display of all measured parameters
- Customizable display of up to 10 numerical measurement functions at a time

For more information, see the specifications document.

2.2 Documentation overview

This section provides an overview of the R&S NPA user documentation. Unless specified otherwise, you find the documents at:

www.rohde-schwarz.com/manual/npa

Further documents are available at:

www.rohde-schwarz.com/product/npa

2.2.1 Getting started manual

Introduces the R&S NPA power analyzers and describes how to set up and start working with the product. Includes basic operations, typical measurement examples, and general information, e.g. safety instructions, etc. A printed version is delivered with the instrument.

2.2.2 User manual

Contains the description of all instrument modes and functions. It also provides an introduction to remote control, a complete description of the remote control commands with programming examples, and information on maintenance and instrument interfaces. Includes the contents of the getting started manual.

The user manual is also available for download or for immediate display on the Internet.

2.2.3 Tutorials

Tutorials offer guided examples and demonstrations on operating the R&S NPA power analyzers. They are provided on the product page of the internet.

2.2.4 Service manual

Describes the performance test for checking the rated specifications, module replacement and repair, firmware update, troubleshooting and fault elimination, and contains mechanical drawings and spare part lists.

The service manual is available for registered users on the global Rohde & Schwarz information system (GLORIS):

See <https://gloris.rohde-schwarz.com>

2.2.5 Instrument security procedures

Deals with security issues when working with the R&S NPA in secure areas. It is available for download on the internet.

2.2.6 Printed safety instructions

Provides safety information in many languages. The printed document is delivered with the product.

2.2.7 Specifications and product brochures

The specifications document, also known as the data sheet, contains the technical specifications of the R&S NPA. It also lists the firmware applications and their order numbers, and optional accessories.

The brochure provides an overview of the instrument and deals with the specific characteristics.

See www.rohde-schwarz.com/brochure-datasheet/npa

2.2.8 Calibration certificate

The document is available on <https://gloris.rohde-schwarz.com/calcert>. You need the device ID of your instrument, which you can find on a label on the rear panel.

2.2.9 Release notes and open source acknowledgment (OSA)

The release notes list new features, improvements and known issues of the current firmware version, and describe the firmware installation.

The firmware uses several valuable open source software packages. An open source acknowledgment document provides verbatim license texts of the used open source software.

See www.rohde-schwarz.com/firmware/npa

2.2.10 Application notes, application cards, white papers, etc.

These documents deal with special applications or background information on particular topics.

See www.rohde-schwarz.com/application/npa

2.2.11 Remote control driver

The instrument drivers enable remote control via the corresponding interfaces. The drivers and installation instructions are available for download on the product page at:

www.rohde-schwarz.com/driver/npa

3 Getting started

This section contains the information you have received as a printed book together with your instrument. The information is provided again to enable you to search throughout the complete description.

3.1 Preparing for use

Here, you can find basic information about setting up the product for the first time.

3.1.1 Lifting and carrying

See ["Lifting and carrying the product"](#) on page 10.

For mounting the R&S NPA in a rack, see [Chapter 3.1.4.2, "Mounting the product in a rack"](#), on page 20.

3.1.2 Unpacking and checking

1. Unpack the product carefully.
2. Retain the original packing material. Use it when transporting or shipping the product later.
3. Using the delivery notes, check the equipment for completeness.
4. Check the equipment for damage.

If the delivery is incomplete or equipment is damaged, contact Rohde & Schwarz.

See [Chapter 15, "Transporting"](#), on page 251.

3.1.3 Choosing the operating site

Specific operating conditions ensure proper operation and avoid damage to the product and connected devices. For information on environmental conditions such as ambient temperature and humidity, see the specifications document.

For safety information, see ["Choosing the operating site"](#) on page 10.

Electromagnetic compatibility classes

The electromagnetic compatibility (EMC) class indicates where you can operate the product. The EMC class of the product is given in the specifications document.

- Class B equipment is suitable for use in:

- Residential environments
- Environments that are directly connected to a low-voltage supply network that supplies residential buildings
- Class A equipment is intended for use in industrial environments. It can cause radio disturbances in residential environments due to possible conducted and radiated disturbances. It is therefore not suitable for class B environments. If class A equipment causes radio disturbances, take appropriate measures to eliminate them.

3.1.4 Setting up the product

For safety information, see:

- ["Setting up the product"](#) on page 10
- ["Intended use"](#) on page 9

3.1.4.1 Placing the product on a bench top

To place the product on a bench top

1. Place the product on a stable, flat and level surface. Ensure that the surface can support the weight of the product. For information on the weight, see the specifications document.
2. **CAUTION!** Foldable feet can collapse. For safety information, see ["Setting up the product"](#) on page 10.
Always fold the feet completely in or out. With folded-out feet, do not place anything on top or underneath the product.
3. **WARNING!** A stack of products can fall over and cause injury. Never stack more than three products on top of each other. Instead, mount them in a rack.
Stack as follows:
 - If the products have foldable feet, fold them in completely.
 - It is best if all products have the same dimensions (width and length). If the products have different dimensions, stack according to size and place the smallest product on top.
 - Do not exceed the permissible total load placed on the product at the bottom of the stack:
 - 50 kg when stacking products of identical dimensions (left figure).
 - 25 kg when stacking smaller products on top (middle figure).

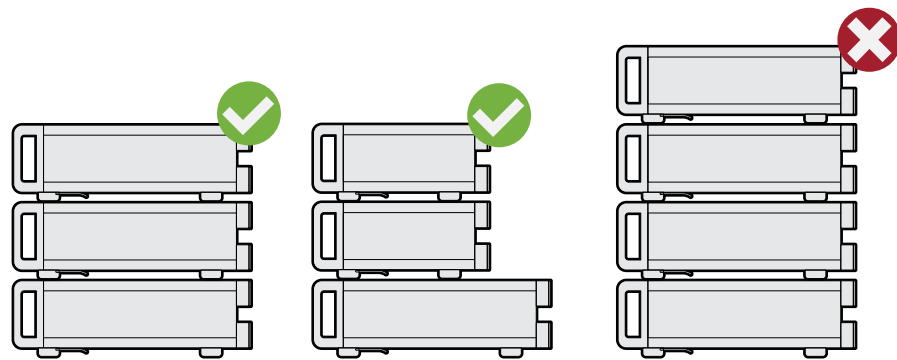

Left = Stacked correctly, same dimensions
 Middle = Stacked correctly, different dimensions
 Right = Stacked incorrectly, too many products

4. **NOTICE!** Overheating can damage the product.

Prevent overheating as follows:

- Keep a minimum distance of 10 cm between the fan openings of the product and any object in the vicinity to provide sufficient airflow and ventilation.
- Do not place the product next to heat-generating equipment such as radiators or other products.

3.1.4.2 Mounting the product in a rack

To prepare the rack

1. Observe the requirements and instructions in "[Setting up the product](#)" on page 10.
2. **NOTICE!** Insufficient airflow can cause overheating and damage the product. Design and implement an efficient ventilation concept for the rack.

To mount the product in a rack

1. Use an adapter kit to prepare the R&S NPA for rack mounting.
 - a) Order the rack adapter kit designed for the R&S NPA power analyzers. For the order number, see the specifications document.
 - b) Mount the adapter kit. Follow the assembly instructions provided with the adapter kit.
2. Lift the R&S NPA to shelf height.
3. Push the R&S NPA onto the shelf until the rack brackets fit closely to the rack.
4. Tighten all screws at the rack brackets with a tightening torque of 1.2 Nm to secure the R&S NPA at the rack.

To unmount the product from a rack

1. Loosen the screws at the rack brackets.

2. Bring the lifting equipment to shelf height.
3. Remove the R&S NPA from the rack.
4. If placing the R&S NPA on a bench top again, unmount the adapter kit from the R&S NPA. Follow the instructions provided with the adapter kit.

3.1.5 Considerations for test setup

Cable selection and electromagnetic interference (EMI)

Electromagnetic interference (EMI) can affect the measurement results.

To suppress electromagnetic radiation during operation:

- Use high-quality shielded cables, for example:
 - Double-shielded data cables for connecting external devices. The length of data cables must not exceed 3 m.
 - Shielded cables (RG58/U coaxial cable) for signal transmission connections. The length of signal cables must not exceed 1 m.
 - Double-shielded USB cables. The length of passive USB cables must not exceed 1 m.
 - CAT6+ LAN cables, e.g. RJ-45 with a length ≤ 3 m.
 - Double-shielded IEEE-488 (GPIB) bus cables. We recommend that you use the double-shielded cable "R&S HZ72" from Rohde & Schwarz (GPIB-cable 2 m, order no. 3594.4269.02).
- Cables for output supply:
 - Use insulated cables of the same type
 - Keep the cable length as short as possible
 - Use cables with maximum cross-section to minimize the conductor resistance
- Always terminate open cable ends.
- Ensure that connected external devices comply with EMC regulations.
- Check regularly that all cables, including power cables are in perfect condition.

Input and output levels

Information on voltage levels is provided in the specifications document. Keep the voltage levels within the specified ranges to avoid damage to the product and connected devices.

3.1.6 Preparing for mains voltage

The R&S NPA is designed for 115 V or 230 V mains voltage. The range is specified on the label next to the AC power supply, see [Rear view > "AC power supply"](#) on page 36, and in the specifications document.

If the mains voltage exceeds the permissible range, contact the Rohde & Schwarz customer service, see [Chapter 14.4, "Contacting customer support"](#), on page 249.

Take care to adjust the R&S NPA to the supplied mains voltage. When delivered, the R&S NPA is configured for 230 V mains voltage.

The product is protected with a line fuse. The suitable fuse type depends on the supplied mains voltage. [Table 3-1](#) shows the suitable fuse types.

Table 3-1: Fuse types

Mains voltage	Fuse F1/F2
115 V	IEC60127-2/5 - F630H/250V, order no. 3622.2330.00
230 V	IEC60127-2/5 – F400H/250V, order no. 3622.2323.00

3.1.6.1 Preparing for 115 V

If you want to supply the R&S NPA with 115 V mains voltage, you need to do the following:

- ["To change the fuse"](#) on page 22
- ["To set the supplied mains voltage"](#) on page 23

To change the fuse

The fuses for 115 V mains voltage are delivered with the R&S NPA.

1. **WARNING!** The fuse is part of the AC power supply. Handling the fuse while the power is on can lead to electric shock.
Before changing the fuse, disconnect the product from the power source.
2. Insert a flathead screwdriver with a blade width of approximately 2 mm under the small opening tab of the fuse holder.

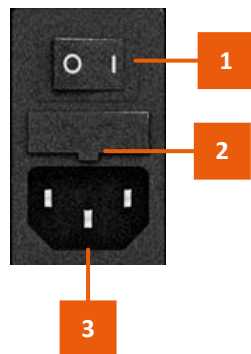

Figure 3-1: AC power connector

- 1 = Power supply switch
- 2 = Opening tab of the fuse holder
- 3 = AC power supply connector

When unlocking the mechanism, the fuse holder is pushed outwards by compression springs.

3. Pull out the fuse holder.
4. Lever out the fuse.
Keep the fuse for later use, if intact.
5. **WARNING!** If the fuse protection is insufficient, the R&S NPA can overheat and even cause a fire.
Check the fuse rating on the caps of the fuse that is delivered with the R&S NPA. Make sure that the fuse type matches the characteristics that are indicated next to the fuse holder for 115 V mains voltage.
6. Inspect the compression springs of the fuse holder carefully. With deformed or protruding springs, you cannot insert the fuse properly. Contact Rohde & Schwarz at <http://www.customersupport.rohde-schwarz.com>.
7. Insert the fuses into the groove of the fuse holder.
8. Align the fuse holder with the guide bar facing the socket.
9. Carefully slide the fuse holder against the spring pressure into the slot until both plastic locks latch.

To set the supplied mains voltage

The **AC power supply voltage selector switch** is on the **rear panel**.

- ▶ To set to 115 V mains voltage, use a tool e.g. a flat screwdriver to slide the voltage selector so that the label indicates *115 V*.

3.1.6.2 Reverting to 230 V

If needed, you can revert to 230 V mains voltage by:

- Inserting the fuse for 230 V mains voltage.
- Selecting 230 V as supplied mains voltage.

3.1.7 Connecting to power

For safety information, see:

- "[Connecting to power](#)" on page 11
- "[Working with hazardous voltages](#)" on page 11

To ground the chassis

The protective ground terminal  on the **rear panel** enables you to connect a ground cable firmly with a screw, see "[Ground terminal](#)" on page 36.

See also [Chapter 1.2, "Labels on the R&S NPA power analyzers"](#), on page 13

1. Unscrew the screw of the ground terminal using a cross-recess screw driver.
2. Attach a ground cable with a ring terminal and pass the screw through it.

3. Tighten the screw to 1.2 Nm using a torque wrench.
4. Connect the cable to ground.

To connect to AC supply

1. If necessary, ground the chassis of the R&S NPA. See ["To ground the chassis"](#) on page 23.
2. **WARNING!** If the fuse protection is insufficient, the R&S NPA can overheat and even cause a fire.
Ensure that R&S NPA is prepared for the supplied mains voltage. See [Chapter 3.1.6, "Preparing for mains voltage"](#), on page 21.
3. Plug the AC power cable into the AC power supply connector. Only use the AC power cable delivered with the R&S NPA.
4. Plug the AC power cable into a power outlet with ground contact.
Do not use a cheater plug or other means to bypass or disconnect the protective ground lead.
The required ratings are listed on the rear panel of the R&S NPA, see [rear panel](#).

3.1.8 Connecting to LAN

The R&S NPA power analyzers provide Ethernet (LAN) connectivity. If you have assigned the corresponding rights, you can use this interface for remote control and data transfer from a controller PC. Make sure that you have connected the controller PC in the same network.

Consult your network administrator before performing the following tasks to avoid a network failure:

- Connecting the instrument to the network
- Configuring the network
- Changing IP addresses

For remote control over other interfaces, refer to the description in [Chapter 12, "Network operation and remote control"](#), on page 162.

To operate the instrument securely

1. **NOTICE!** The R&S NPA is designed to operate at local workplaces or in secured networks (LAN).
When connected to the LAN, the R&S NPA can potentially be accessed from the internet, which constitutes a security risk. For example, attackers can misuse or damage your device.
Use secured connections for internet or remote access, if applicable.
2. Ensure that the network settings comply with the security policies of your company. Contact your local system administrator or IT department before connecting your product to your company LAN.

3. Always install the latest firmware.

To connect to LAN

The LAN connector is on the [rear panel](#).

1. **WARNING!** Risk of electric shock. With certain test setups, you achieve higher voltages and currents. Observe the safety information in "[Working with hazardous voltages](#)" on page 11.

Ensure that all products are grounded by connecting them to the AC power.

2. Connect the LAN socket using an RJ-45 cable to the LAN.

By default, the R&S NPA is configured to use DHCP that assigns the IP address automatically.

If the R&S NPA cannot obtain an IP address automatically, it returns a time-out message after about three minutes and clears the parameters in the "Ethernet Settings" dialog. Possible reasons are that the LAN does not support DHCP or requires a specific TCP/IP configuration, or that the connection is missing.

3. If the time-out message is displayed, proceed as follows:
 - a) Check if you have connected of both, the R&S NPA and the controller PC to the LAN.
 - b) Consult your network administrator to request support and an IP address, if necessary.
 - c) If necessary, assign the IP address manually as described in [Chapter 12.4, "Adjusting the interface addresses"](#), on page 177.

If connected and switched on, the R&S NPA indicates the address information and LAN parameters in the "Ethernet Settings" dialog.

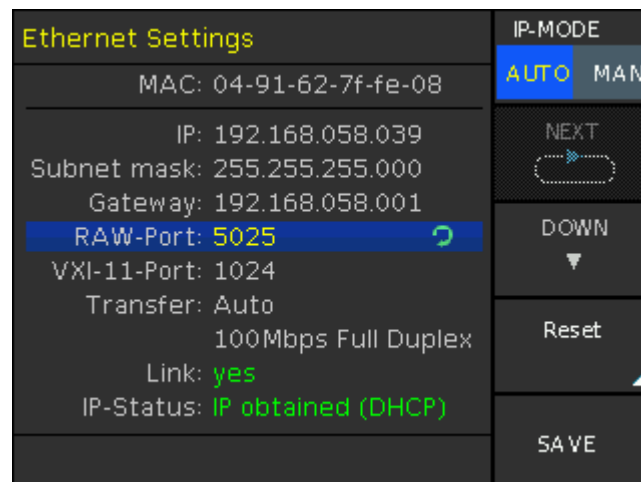

Figure 3-2: Ethernet settings dialog

See [Chapter 12.2.2, "Ethernet settings"](#), on page 172. For information on how to control the instrument remotely, see "[To start a remote control session](#)" on page 182.

3.1.9 Connecting USB devices

The USB A connector is on the [front panel](#).

You can connect or disconnect all USB devices from the R&S NPA during operation. But do not remove an external USB memory stick during a firmware update, data logging and storing screen captures, as it can lead to unsuccessful updates and loss of data.

To connect USB storage devices

USB storage devices, such as memory sticks, allow easy data transfer from/to the R&S NPA. You can also use them for firmware updates.

- ▶ Connect the USB storage device to the USB type A connector directly, without connecting cable.
Connecting cables can cause electromagnetic radiation and impair the measurement result.

3.1.10 Connecting a device under test (DUT)

For safety information, see "[Working with hazardous voltages](#)" on page 11.

The R&S NPA power analyzer enables you to measure AC/DC loads and current characteristics with different measurement methods.

As a brief introduction, the following test setup example describes the basic steps to be taken when setting up a measurement with the R&S NPA-Zx test adapter. See also the installation instructions of the R&S NPA-Zx test adapter.

For further applications and test setups, see [Chapter 4, "Measurement setups"](#), on page 47.

Test setup

This setup shows the R&S NPA-Zx test adapter connected to the R&S NPA power analyzer, and a DUT connected to the adapter.

The R&S NPA-Zx test adapter is like a standard AC outlet with grounded safety sockets. The three connections V, A and COM to the power analyzers transmit the mains values for the measurement.



Figure 3-3: Measurement setup of the R&S NPA and the R&S NPA-Zx to a DUT

- 1 = R&S NPA power analyzer
- 2 = R&S NPA-Zx test adapter
- 3 = Power supply of the R&S NPA-Zx (cord with IEC plug)
- 4 = DUT power plug
- 5 = A, COM and V connection cables

To connect the R&S NPA-Zx test adapter to the R&S NPA power analyzer

See also [Figure 3-3](#).

1. Use the cables delivered with the R&S NPA-Zx test adapter, as they are aligned for connection of the R&S NPA-Zx to the R&S NPA power analyzer.
If you use other measurement equipment, ensure that it fulfills the requirements as described in the R&S NPA-Zx installation instructions, chapter "Connecting to the R&S NPA power analyzer and the DUT".
2. Inspect the cables and the cable connectors to ensure that they are not damaged.
Note: If the visual inspection shows any damage, replace the cable.
3. Inspect the A, COM and V safety sockets of both, the R&S NPA and the R&S NPA-Zx visually to check that they are clean, undamaged and mechanically compatible.
Note: If the visual inspection shows that a connector requires cleaning, see [Chapter 16.1, "Cleaning"](#), on page 252.
4. To connect the R&S NPA to the R&S NPA-Zx:
 - a) Connect the black cable to the COM safety socket of the R&S NPA "[Measurement connectors](#)" on page 33.
 - b) Connect the blue cable to the A, and the red cable to the V safety sockets.
 - c) Stick to the color and connect the cables to the COM, A and V safety sockets of the R&S NPA-Zx.
5. To connect the R&S NPA and the R&S NPA-Zx to the AC supply:

- a) Power on the R&S NPA, as described in [Chapter 3.1.7, "Connecting to power"](#), on page 23.
- b) Power on the R&S NPA-Zx as described in the R&S NPA-Zx test adapter installation instructions, chapter "Connecting to power".
- c) Switch on the R&S NPA, see [Chapter 3.1.11, "Switching on or off"](#), on page 28.

Tip: The R&S NPA-Zx does not have an On/Off switch.

To connect to the DUT

1. **NOTICE!** Risk of damage to the R&S NPA-Zx. The R&S NPA-Zx test adapter standard AC ground safety outlet system is approved for a 10 A continuous load. Higher loads can damage or even destroy the device.
Ensure that the load meets the values specified in the specifications document.
2. Plug in the power cable of the DUT into the DUT power plug of the R&S NPA-Zx test adapter.
3. To configure and execute a measurement, continue as described in the examples under [Chapter 3.3, "Trying out the instrument"](#), on page 37.

See also the installation instructions of the R&S NPA-Zx test adapter.

3.1.11 Switching on or off



For safety reason, switch off the mains switch when the R&S NPA is not in use.

To switch on the R&S NPA

The instrument is off but connected to power, see [Chapter 3.1.7, "Connecting to power"](#), on page 23.

1. Set the AC power supply switch on the [rear panel](#) to position [I].
The LED of the standby key lights red, see ["POWER On/Standby key"](#) on page 33.
2. Press the standby key on the [front panel](#).
The LED of the standby key turns off. The instrument performs a system check, boots the operating system, and starts the firmware.
At restart, the R&S NPA starts up in the operating mode used before the last switch-off.

Note: Initially, the R&S NPA displays a help screen.

3. To hide the help screen, press the key next to the "Hide" softkey on the front panel.

Tip: The "Hide Forever" softkey deactivates the automatic display of the help screen when starting the instrument.

To shut down the product

- ▶ Press the standby key.

All current settings are saved and the operating system shuts down. The LED of the standby key changes to red.

To disconnect from power

The product is in the standby state.

1. **NOTICE!** Risk of data loss. If you disconnect the product from power when it is in the ready state, you can lose settings and data. Shut it down first.

Set the switch on the power supply to position [0].

The LED of the standby key is switched off.

2. Disconnect the product from the power source.

3.1.12 Configuring the initial instrument settings

Basically, you can start working with the R&S NPA without any special initial settings. If necessary, you can set the internal clock to the current date and time when you put it into operation the first time.

This section describes how to set up date the R&S NPA initially. For further basic instrument settings, see the R&S NPA user manual.

To set date and time of the instrument internal clock

1. Press the [SETUP] key on the front panel.
2. In the setup softkey menu, press the "Misc" softkey.

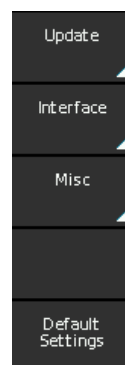

Figure 3-4: Setup softkey menu

3. In the miscellaneous menu, select the "Date & Time" softkey.

The "Set Date & Time" dialog opens. It indicates the date and time of the internal clock. Yellow digits are editable.

4. Turn the [rotary knob] to increase or decrease, e.g., the "<year>" digits.

5. Press the [rotary knob] to confirm the setting.
6. Select the following digits with the right [▶] arrow key.
7. Repeat steps (step 4 to step 6) to complete the date and time setting.
8. Press the [rotary knob] to confirm the setting.

The R&S NPA uses the information for assigning a time stamp to saved measurement readings and printed outputs during operation.

3.2 Instrument tour

The instrument tour provides an overview of the front control elements and connectors of the R&S NPA instrument models.

The meanings of the labels on the R&S NPA are described in [Chapter 1.2, "Labels on the R&S NPA power analyzers"](#), on page 13.

3.2.1 Front view

Depending on the R&S NPA instrument model, some of the connectors and control elements are not available.

[Figure 3-5](#) shows the front view of the R&S NPA101 power meter instruments. The power meter has no sensor input connectors.



Figure 3-5: Front view of the R&S NPA101

- 1 = [Display](#)
- 2 = ["Interactive softkeys"](#) on page 32
- 3 = ["System and function keys"](#) on page 32

- 4 = "Navigation controls" on page 33.
- 5 = Measurement input connectors, see "Measurement connectors" on page 33
- 6 = Back key, see "Navigation controls" on page 33
- 7 = USB connector, see "USB A" on page 34
- 8 = "POWER On/Standby key" on page 33

Figure 3-6 represents the R&S NPA701(-G) and also the R&S NPA501(-G) power analyzer as the front views of both instrument models are the same.

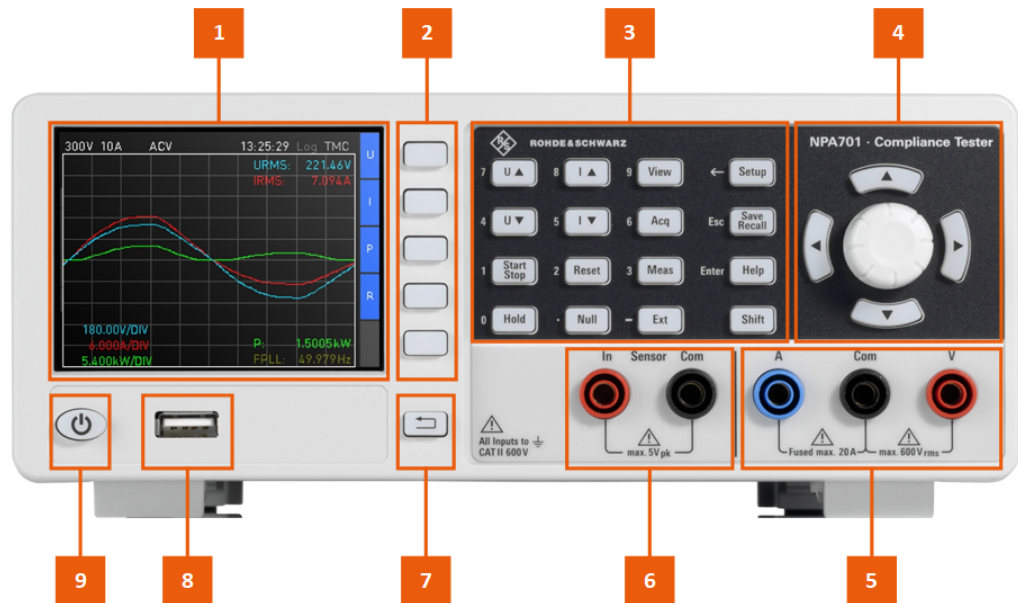

Figure 3-6: Front view of the R&S NPA701(-G) and R&S NPA501(-G)

- 1 = Display
- 2 = "Interactive softkeys" on page 32
- 3 = "System and function keys" on page 32
- 4 = "Navigation controls" on page 33.
- 5 = Measurement input connectors, see "Measurement connectors" on page 33
- 6 = Sensor input connectors, see "Sensor connectors" on page 33
- 7 = Back key, see "Navigation controls" on page 33
- 8 = USB connector, see "USB A" on page 34
- 9 = "POWER On/Standby key" on page 33

3.2.1.1 Display

The color display indicates the measurement readings and dialogs for configuring the instrument and measurement settings. The screen display provides status and setting information and allows you to access functions and settings with the interactive softkeys.

See Chapter 3.4.2.1, "Understanding the display information", on page 41.

3.2.1.2 Keys

This section describes briefly the functionality of the controls. For information on how to operate the instrument, see [Chapter 3.4.2, "Means of manual interaction"](#), on page 40.

Interactive softkeys

The interactive softkeys to the right of the display provide access to submenus and functions of the instrument, depending on the selected view.

System and function keys

System and function keys provide access to the instrument settings and functions.

Table 3-2: Measurement parameter keys

Key	Assigned functions
[U ▲] ¹⁾ [U ▼] ¹⁾	Increase or decrease the voltage range manually in predefined steps.
[I ▲] ¹⁾ [I ▼] ¹⁾	Increase or decrease current range manually in predefined steps.
[VIEW]	Switches between the display modes. The supported views depend on the instrument models: <ul style="list-style-type: none"> numerical views: R&S NPANPA101, R&S NPA501(-G) and R&S NPA701(-G) graphical views: R&S NPA501(-G) and R&S NPA701(-G)
[ACQ]	Opens the data acquisition menu to configure how the instrument acquires measurement data.
[START/STOP]	Starts/stops the energy counter.
[HOLD]	Stops the update of measurement values.
[RESET]	Resets the energy counter.
[NULL]	Sets the current display values as zero reference values and displays deviations.
[MEAS]	Opens the measurement menu to select the measurement mode. The supported measurement modes depend on the instrument models: <ul style="list-style-type: none"> "Integrator" and "Logging": R&S NPA101, R&S NPA501(-G), R&S NPA701(-G) "Limit": R&S NPA501(-G), R&S NPA701(-G) Standards: R&S NPA701(-G)
[EXT]	Depends on instrument models: <ul style="list-style-type: none"> R&S NPA101: not supported, the instrument beeps on using the key R&S NPA501(-G), R&S NPA701(-G): Opens the external measurement menu to configure the settings when using external probes.
¹⁾ Pressing and holding the key activates the automatic adjustment ("AUTORANGE") of the measurement range. You can activate autorange for the acquisition parameters U and I separately.	

Table 3-3: Utility keys

Key	Assigned functions
[SETUP]	Opens the menu to configure general instrument settings.
[SAVE/RECALL] ²⁾	Saves and loads instrument settings and provides access to configure the screenshot functionality.
[HELP]	Displays integrated help topics.
[SHIFT]	Activates the numeric keypad for setting when applicable.
²⁾ Pressing and holding the key saves the screenshot to a USB memory device, if connected.	

Navigation controls

The navigation controls include a rotary knob, arrow keys, and the back key. The arrow keys light up, when you can use them and the rotary knob for your settings. They allow to navigate within the main view, menus and dialogs, see "[Navigation controls](#)" on page 43.

Table 3-4: Navigation controls

Key	Assigned functions
[Rotary knob]	Pressing the knob opens or confirms a setting. Turning the knob allows to adjust a setting, e.g. in an on-screen value list.
[▲] / [▼] / [▲] / [▼] ²⁾	Navigate up, down, right or left to select settings, when navigation is available.
[back]	Returns to the previous menu level or closes a view.

POWER On/Standby key

The [On/Standby] key switches the instrument from the standby to the ready state or vice versa. In standby state, the LED of the [On/Standby] key lights red.

See [Chapter 3.1.11, "Switching on or off"](#), on page 28.

3.2.1.3 Connectors

The measurement input connectors and the USB connector are on the front panel.

Measurement connectors

Measurement input connectors.

4 mm safety sockets:

- A: Input for current measurement.
- COM: Common (shared) ground for voltage and current measurement.
- V: Input for voltage measurement.

Sensor connectors

Instrument models R&S NPA501(-G) / R&S NPA701(-G)

Sensor input connectors used for measurements with external shunts or current clamps.

4 mm safety sockets:

- IN: Input for external shunt or current probes.
- COM: Measurement ground for voltage and current measurement.

USB A

USB type A connector, to connect a memory device.

3.2.2 Rear view

This section provides an overview of the connectors on the rear panel of the instrument. For technical data of the connectors, refer to the specifications document.

Figure 3-7 shows the rear panel view of the R&S NPA101 power meter instruments. The power meter has no IEC 625/IEEE 488 interface and no analog and digital connectors.

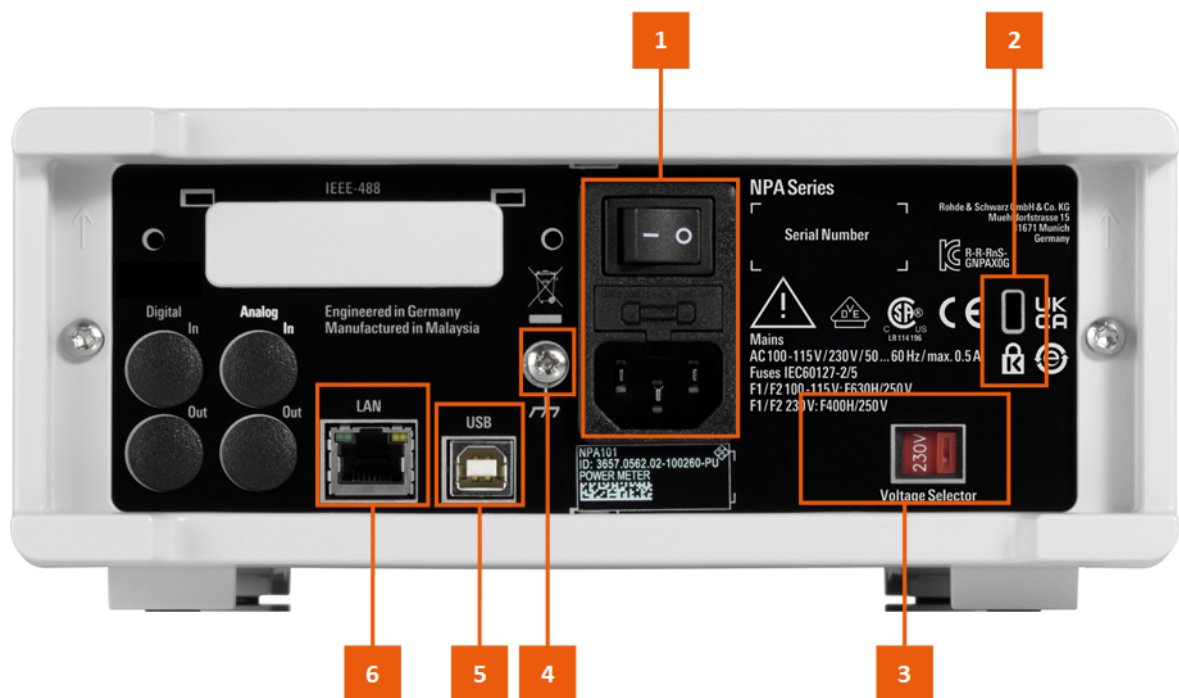

Figure 3-7: Rear view of the R&S NPA101

- 1 = "AC power supply" on page 36
- 2 = "Kensington lock" on page 36
- 3 = "AC power supply voltage selector switch" on page 36
- 4 = "Ground terminal" on page 36
- 5 = USB host connector, see "USB B" on page 36
- 6 = Ethernet (LAN) interface, see "LAN" on page 36

Figure 3-8 represents the R&S NPA701(-G) and also the R&S NPA501(-G) power analyzer as both instrument models provide the same interfaces and connectors.

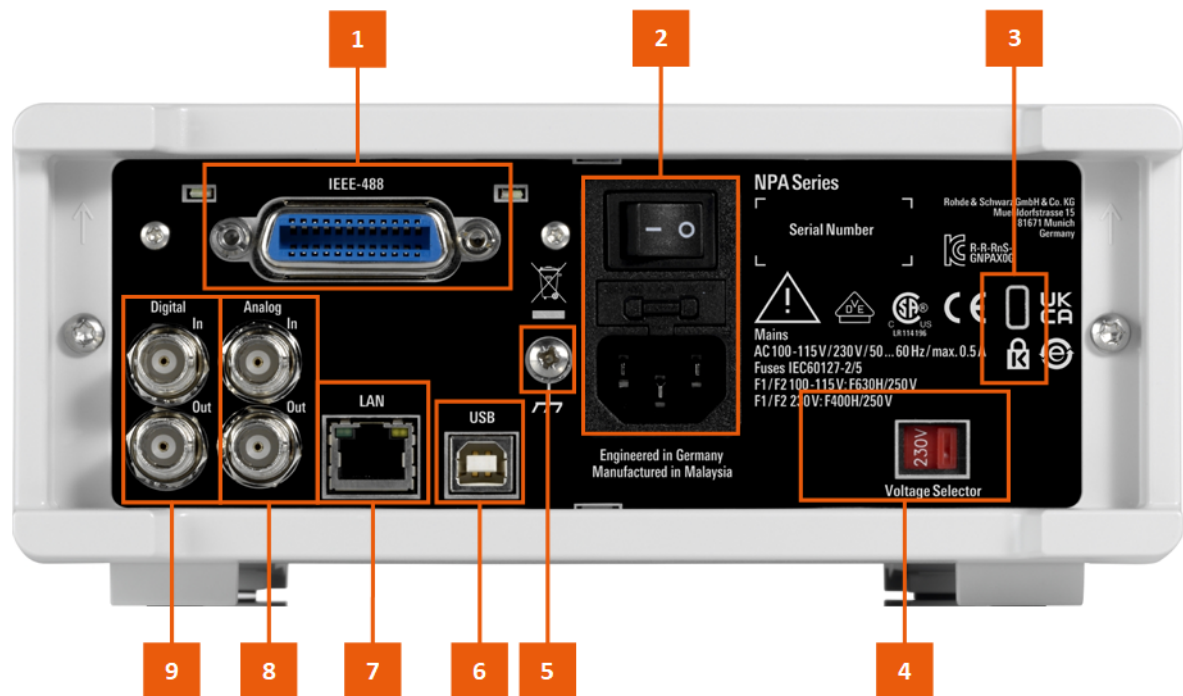

Figure 3-8: Rear view of the R&S NPA501(-G) and R&S NPA701(-G)

- 1 = IEEE 488 (GPIB) interface (instrument models R&S NPA501-G, R&S NPA701-G), see "[IEC 625/IEEE 488](#)" on page 35
- 2 = "[AC power supply](#)" on page 36
- 3 = "[Kensington lock](#)" on page 36
- 4 = "[AC power supply voltage selector switch](#)" on page 36
- 5 = "[Ground terminal](#)" on page 36
- 6 = USB host connector, see "[USB B](#)" on page 36
- 7 = Ethernet (LAN) interface, see "[LAN](#)" on page 36
- 8 = "[ANALOG IN, ANALOG OUT](#)" on page 35
- 9 = "[DIGITAL IN, DIGITAL OUT](#)" on page 35

3.2.2.1 Connectors

DIGITAL IN, DIGITAL OUT

Instrument models R&S NPA501(-G), R&S NPA701(-G)

Connectors for digital inputs and outputs, e.g. to display "Pass/Fail" status information. At the digital output, you can apply a limit value.

ANALOG IN, ANALOG OUT

Instrument models R&S NPA501(-G), R&S NPA701(-G)

Connectors for analog inputs and outputs, e.g. to display "Pass/Fail" status information. At the analog output, you can apply a limit value.

IEC 625/IEEE 488

Instrument models: R&S NPA501-G, R&S NPA701-G

GPIB (general purpose interface bus) interface to connect a computer for remote control of the R&S NPA. To set up the connection, use high-quality shielded cables.

See [Chapter 12.1, "Remote control interfaces and protocols"](#), on page 162.

LAN

RJ-45 connector to connect the R&S NPA to a LAN (local area network) for remote control, remote operation, and data transfer.

How to: [Chapter 3.1.8, "Connecting to LAN"](#), on page 24

USB B

USB type B connector, to connect a computer for remote control of the R&S NPA.

See [Chapter 12.1, "Remote control interfaces and protocols"](#), on page 162.

How to: [Chapter 12.3.2, "Connecting the R&S NPA to the USB interface"](#), on page 176.

Ground terminal

Protective ground socket to secure the R&S NPA, e.g. with a grounded external conductor.

See [Chapter 1.2, "Labels on the R&S NPA power analyzers"](#), on page 13.

AC power supply

Mains power supply with power switch, fuse holder and IEC socket.

- Mains power switch:
Switch for connecting and disconnecting the internal power supply from the power source, see [Chapter 3.1.11, "Switching on or off"](#), on page 28.
- Fuse holder
Socket for the fuse securing the line voltage. Depending on the power supply system, the corresponding fuse must be plugged before connecting to power. See [Chapter 3.1.7, "Connecting to power"](#), on page 23.
- IEC socket
Power supply connector for connecting the R&S NPA to the mains, see [Chapter 3.1.7, "Connecting to power"](#), on page 23.

AC power supply voltage selector switch

Switch for selecting the line voltage 115 V or 230 V.

How to: [Chapter 3.1.7, "Connecting to power"](#), on page 23.

Kensington lock

Flat key security slot to prevent the instrument from removal.

A Kensington lock system consists of a small, metal-reinforced hole combined with a metal anchor attached to a rubberized metal cable secured with a key lock. The end of the cable has a small loop that allows the cable to be looped around a permanent object, such as a heavy table or other similar equipment.

3.3 Trying out the instrument

The R&S NPA power analyzers provide manually settable measurements, and automated test procedures. The automated test procedures comply with the requirements of specific standards for power measurement and analysis. The following examples introduce step by step a typical power measurement with any model of the R&S NPA power analyzers, and an automated compliance test with an R&S NPA701 instrument, supported by the verification wizard.

For the description of the complete functionality of the R&S NPA, see the R&S NPA power analyzers user manual. For basic instrument operation, see [Chapter 3.4, "Instrument control"](#), on page 40.

Prerequisites:

- The R&S NPA is set up, connected to power and started up as described in [Chapter 3.1.4, "Setting up the product"](#), on page 19.
- The measurement is set up with the DUT connected to the R&S NPA-Zx test adapter, as described in [Chapter 3.1.10, "Connecting a device under test \(DUT\)"](#), on page 26.

Measuring the power characteristics of a load

This measurement example describes a typical numeric measurement application of the R&S NPA101 power meter. The example leads you through the steps to be taken to measure and view the readings in numeric mode. It shows, how to select the parameters for the display individually, and how to export the results of the measurement for evaluating, e.g. on a PC application.

To start the measurement

1. Set the instrument to default to start from an initial state:
 - a) Press the [SETUP] key on the front panel.
 - b) In the setup menu, select the "Default Settings" softkey.

The instrument displays the "Help" topic with short instructions on the setting, e.g. the numeric mode.

2. Select the "Hide" softkey to close the "Help" topic.
3. Press the [VIEW] key.
4. Select the "Numeric" softkey.

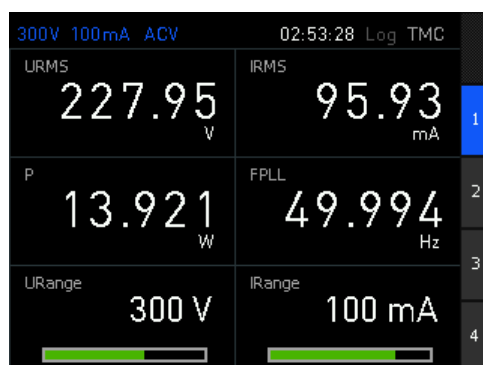

Figure 3-9: Numeric view

The instrument starts the measurement immediately and updates the measurement readings continuously.

The numeric display shows the readings of six measurement parameters, as listed in [Table 3-5](#).

Table 3-5: Parameters displayed in numeric view

Parameter	Description (unit)	Parameter	Description (unit)
"URMS"	True RMS voltage (V)	"IRMS"	True RMS current (mA)
"P"	Active power (mW)	"FPLL"	PLL source frequency (Hz)
"URange"	Range voltage shown as bar graph (V)	"IRange"	Range current shown as bar graph (mA)

To save and export measurement results

To keep measurement results for evaluation, you can save current measurement readings as screenshots to an external USB memory device. This example briefly shows how to save a snapshot of a measurement result.

To record measurement readings over a certain period of time, use the logging function, as described in [Chapter 7.2, "Data logging"](#), on page 80.

The USB connector is on the front panel.

To create and save a snapshot:

1. Plug in a USB memory stick.
2. Press the "HOLD" key.
The R&S NPA freezes the current display.
3. Press and hold the [SAVE/RECALL] key.

The instrument indicates the saving process until it is completed.

The R&S NPA creates a generic file name and saves the file on the memory device with the extension *.png.

To save instrument settings

The R&S NPA can save instrument settings and screenshots. It saves screenshots always on an external USB memory stick, to save instrument settings select either the internal non-volatile memory or the USB stick.

The USB connector is on the front panel.

To create and save a snapshot:

1. Plug in a USB memory stick.
2. Press the [SAVE/RECALL] key on the front panel.
3. Press the "Device Settings" softkey.



Figure 3-10: Device settings softkey

4. Select "Save" to open the save to memory dialog.



Figure 3-11: Save softkey

5. Select the memory location, e.g. "STORAGE" > "Front USB".
6. Confirm with "Accept".
7. Press the "FILE NAME" softkey.

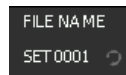
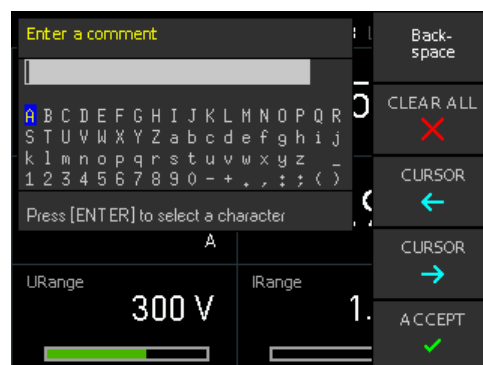

Figure 3-12: File name softkey

The system file manager dialog opens.



8. Assign a filename, if needed.
For settings, the R&S NPA assigns the default filename SETxxxx. "xxxx" refers to an incremental index starting from "0001".

9. Select the "Comment" softkey to add a comment.



Figure 3-13: Comment softkey

The comment appears in the footer of the file manager when the file is selected.

10. Confirm with "Accept".
11. Press the "Save" softkey.

The R&S NPA saves the instrument settings in binary (HDS) format.

3.4 Instrument control

This chapter provides an overview on how to work with the R&S NPA. It introduces the possibilities for operating the instrument and describes the basic functionality of the control elements.

- [Ways to operate the instrument](#)..... 40
- [Means of manual interaction](#)..... 40
- [Remote control](#)..... 45

3.4.1 Ways to operate the instrument

You can operate an R&S NPA in two ways:

- Manual operation
Use the front panel controls to configure your measurement. The description under [Chapter 3.4.2, "Means of manual interaction"](#), on page 40 shows how to operate the instrument manually.
- Remote control
Create programs to automate repeating settings, tests and measurements. A controller PC with remote access to the instrument runs the programs. See [Chapter 3.4.3, "Remote control"](#), on page 45 for an overview of the interfaces provided for remote control.

3.4.2 Means of manual interaction

To configure the R&S NPA manually, use the front panel controls, see [Chapter 3.2.1, "Front view"](#), on page 30. The display shows the current settings and measurement results. Interactive softkeys lead you to menus, dialogs and settings.

- [Understanding the display information](#)..... 41
- [Accessing the functionality](#)..... 42
- [Accessing menus and dialogs](#)..... 44
- [Entering data](#)..... 44

3.4.2.1 Understanding the display information

At the top of the display, the R&S NPA shows a status bar. It indicates the set voltage and current measuring ranges, information on the measurement mode and general settings, e.g. the selected interface. On the right-hand side of the screen layout, an interactive softkey menu provides access to the selected measurement functions and settings.

The result field depends on the selected view and the measurement mode. It shows readings either numerically, bar graphs or waveform signals graphically.

Figure 3-14 shows the display of the numeric mode as an example.

For detailed information, see Chapter 8, "Display modes", on page 107.

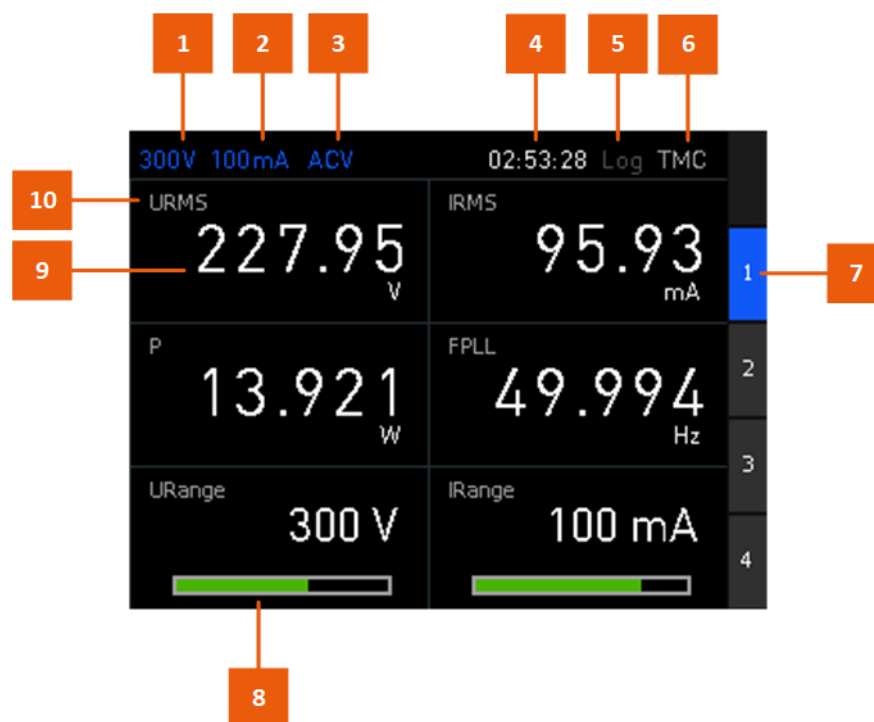



Figure 3-14: Example of screen display in numeric mode

- 1 = Voltage measuring range
- 2 = Current measuring range
- 3 = Acquisition mode
- 4 = System time / integrator duration (when enabled)
- 5 = Logging enabled (green)/disabled (white)
- 6 = Active interface: TMC/VCP/LAN/GPIB
- 7 = Softkeys, in this example to switch between the four available pages of numeric measurements
- 8 = Measuring range and limits shown as bar graph ("URange"/"IRange" function)
- 9 = Measurement reading with unit
- 10 = Measurement parameter

Display indicators and characteristics

Additional display indicators and characteristics:

- General color coding:

- White: measurement readings, parameter labels, parameter settings in the status bar when manually selected, setting dialogs and functions
- Blue: parameter settings in the status bar if automatic selection is enabled, softkey switches
- Orange: selected softkeys, settings in edit mode
- Yellow: general information and messages
- Green: messages and settings parameter names, settings in the status bar
- Red: warnings, notifications on inactive connections and settings
- Selected parameters have a blue background, the inactive counterparts are indicated with a gray background.
- "---" dashes on the display indicate that the R&S NPA could not determine a value.
- "-OL-" on the display indicate that the measured value exceeds the currently selected voltage or current measurement range.
-  symbol indicates the operation with the rotary knob.
- If the NULL function is activated, the R&S NPA displays deviations to the selected reference value on the screen.
- "Fallback" time, an adjustable time period:
When this time period has elapsed, the instrument either closes a setting dialog, returns to a previous dialog or assigns a certain setting automatically without having confirmed manually.
Settings in menus are not affected by the fallback time.
See [FALLBACK](#).

3.4.2.2 Accessing the functionality

The R&S NPA provides all functionalities by function keys, interactive softkeys and the navigation controls on the front panel. This section describes the basic operation for manual interaction with the instrument.

System and function keys

System and function keys include the measurement function keys (see [Table 3-2](#)) and utility keys (see [Table 3-3](#)). Measurement parameter keys enable you to select and to configure the measurement and to select the results display. A selected measurement key lights up, indicating that the function is active. With the utility keys, you can configure general instrument settings, manage data and configuration files and get help information directly on the instrument.

Numeric keypad

The numeric keypad,

Pressing the [SHIFT] key, the R&S NPA switches the measurement function keys to a numeric keypad to enter values for some parameters directly. The key remains lighting while the numeric keypad is active.

With the numeric keypad, you can perform the commonly known actions:

- Insert numbers [0]...[9]

- Insert a decimal point [.]
- Insert negative numbers with the [-] minus key
- Delete a digit [←] (backspace)
- Abort with [EXT]
- Confirm with [ENTER]

A value entered with the numeric keypad must be confirmed to apply the setting. Press either the [ENTER] key, the rotary knob or select one of the proposed units with the softkeys.

Interactive softkeys

The interactive softkeys lead to submenus and functions. They allow you to set states directly or access further settings lists or menus. The instrument assigns the setting options for selection next to the softkeys on the right of the screen.

If a specific setting is in the current configuration not available, the softkey is grayed out and blocked.

Navigation controls

The navigation controls include a rotary knob and arrow keys. They allow you to navigate within a setting, menus or dialogs.

- Rotary knob
 - The rotary knob has several functions:
 - Moves the selection, e.g. to a parameter in a settings dialog by turning clockwise or counterclockwise.
 - Activates the edit mode of a parameter when pressed.
 - Increments (by turning clockwise) or decrements (counterclockwise) a numeric parameter at a defined step size.
 - Acts like the [Enter] key when pressed.
- Arrow keys
 - Move the selection up and down, or forward and backward, e.g. to a parameter in a settings dialog.
 - Return to a previous menu level (left arrow key).
 - In a numeric input field, increase or decrease the value, or navigate to the next or previous position.
- Back  key
 - The actions triggered by pressing this key vary, depending on where you press the key:
 - In menus:
 - Returns to a previous level (similar to the left arrow key). The menu closes when you go back from the first menu level.
 - On the screen display:
 - Resets an activated function, e.g. the edit mode.
 - "Harmonics", "Waveform", "Trendchart" and "Inrush" modes, available for instrument models R&S NPA501(-G), R&S NPA701(-G):

Toggles the softkey menu: folds down the softkey menu to a narrow menu bar. The bar displays the settings in abbreviated form, but still provides quick access to change a setting with the corresponding softkey. Folded out, the softkey menu indicates the parameters and settings in the usual menu size.

3.4.2.3 Accessing menus and dialogs

All functions have the settings and parameters assigned to softkey menus. Use the corresponding softkey on the front panel for accessing submenus and settings.

Throughout the description, the term "menu" refers to selection lists for softkeys and settings, and the term "dialog" refers to editable windows in the instrument.

To open a menu

1. Press a function key on the front panel.
The R&S NPA displays the softkey menu of the selected function. The white arrow tag at the bottom of a softkey indicates that you can access further settings in a submenu.
2. Press the interactive softkey to open the corresponding function.
The selection leads you either to the settings parameters directly, or to further softkey submenus.
3. To access the next submenu, press the corresponding softkey.

To close or exit a dialog or menu

- ▶ Press the  [back] on the front panel.
The instrument returns to the previous menu level or exits the menu mode if it is already at the main menu level.

3.4.2.4 Entering data

Depending on the settings, you can enter data either with the [rotary knob] or the [SHIFT] key and the numeric keypad on the front panel.

Entering numeric parameters

If the input field requires numeric input, you can use the [rotary knob] and the [arrow] keys on the front panel to enter a value. Alternatively, you can use the [SHIFT] key and the numeric keypad on the front panel.

To correct a value

1. Rotate the rotary knob to increase (clockwise direction) or to decrease (counterclockwise direction) to the required value.
2. Alternatively, use the [SHIFT] key on the front panel for setting the numeric value directly.

3. Press the rotary knob to confirm the setting.

Entering alphanumeric data

For input of texts, e.g., file names or designators, the R&S NPA provides an embedded standard editor with an alphanumeric keyboard.

Use the standard editor to perform the following actions:

- Assign names for specific settings, e.g. the instrument name.
- Define a directory or folder.
- Save the settings files.
- Save measurement data files.

To enter a text

The header of the editor shows a generic label, starting with "Enter..." and the parameter you want to enter, e.g. "Enter file name".

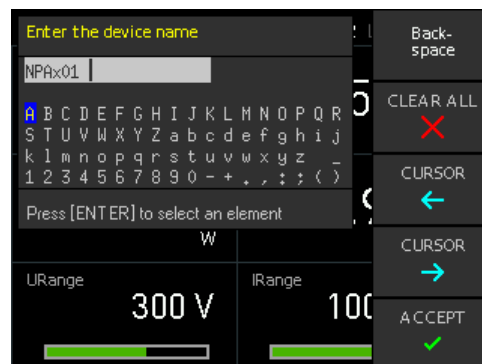

Figure 3-15: Generic standard editor

1. In the "Enter ..." dialog, select a character with the rotary knob.
2. Confirm with the [ENTER] key.
3. Repeat the steps until you have completed the name.
4. For navigation, use the controls in the softkey menu on the right:
 - The "Backspace" softkey deletes the character to the left of the cursor.
 - "Default" assigns the name automatically containing an abbreviated designation and a generic number.
 - "CURSOR ←", "CURSOR →" moves the cursor to the left or to the right.
 - "Accept" confirms the entry and closes the editor.

3.4.3 Remote control

In addition to operating the R&S NPA directly on the instrument, it is also possible to operate and control it from a remote PC.

Remote control interfaces

The R&S NPA provides several interfaces for remote control:

- Ethernet (LAN) interface
- USB standard interface
- IEE-488 bus interface (GPIB) (instrument model R&S NPAXxx-G)

How to:

- Configure the remote control interfaces, see [Chapter 12, "Network operation and remote control"](#), on page 162
- Set up LAN connection for remote control, see [Chapter 3.1.8, "Connecting to LAN"](#), on page 24 for an example on how to set up LAN connection for remote control.
- Start remote operation, see [Chapter 12.5, "Starting and stopping remote control"](#), on page 182

4 Measurement setups

The following description briefly outlines the most important characteristics and aspects of the measurement setups. It also points out the correct cabling and technically required background knowledge that must be considered for the corresponding setups and measurement methods.

The connectors are on the [front panel](#).

To connect a DUT to the R&S NPA for measurements, you have the following options:

- Connecting the DUT using the R&S NPA-Zx test adapter.
This option is described in [Chapter 3.1.10, "Connecting a device under test \(DUT\)"](#), on page 26. It shows a typical test setup with the R&S NPA-Zx test adapter and describes the basic steps to be taken when setting up the measurement.
- Connecting the DUT directly, see [Chapter 4.3, "Connecting a DUT directly"](#), on page 51.
- Using an AC/DC current probe or external shunt, supported by instrument models R&S NPA501(-G), R&S NPA701(-G), see [Chapter 4.4, "Connecting an external AC/DC shunt or clamp-on current probe"](#), on page 52.

Considerations on test setups

- If not denoted explicitly, use the red V connector for voltage measurement, and the blue A connector for current measurement.
The black COM connector is the ground reference for both, voltage or current measurements.
- If the input current in the measurement range ≤ 200 mA for crest factor = 3 exceeds the permissible 2 A, the R&S NPA prompts the notification "Overcurrent Protection". The R&S NPA turns off automatically.

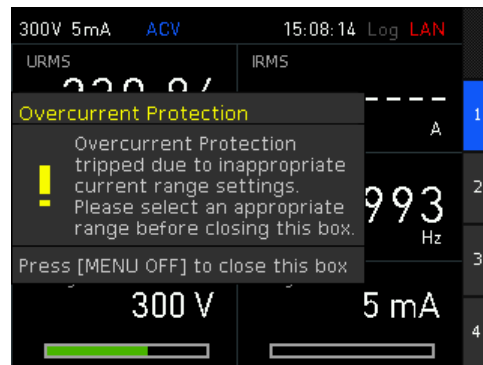

Figure 4-1: Overcurrent protection

To continue the measurement, either adjust the measurement range to 500 mA (for crest factor = 3) manually, or activate the automatic range setting.

- Internal wiring of the R&S NPA
The internal wiring of the A, V, and COM input connectors provides several methods to measure the DUT:

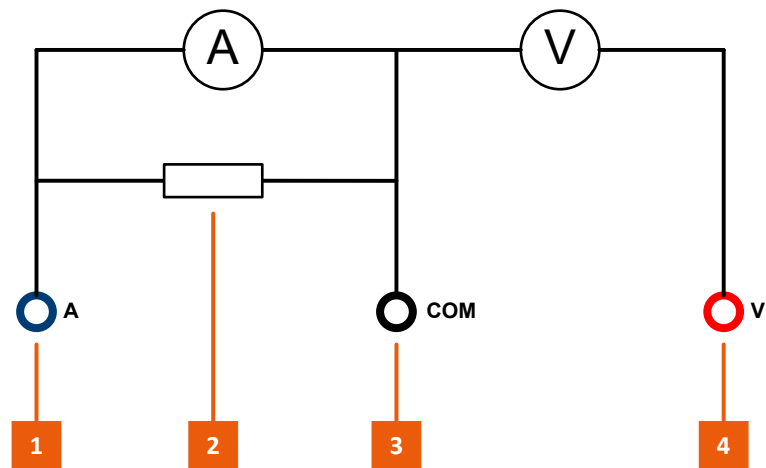

Figure 4-2: Internal wiring of A, V and COM of the R&S NPA

- 1 = Current input connector A
- 2 = Internal shunt
- 3 = Common (shared) ground COM
- 4 = Voltage input connector V

- Current-based measurement, see [Chapter 4.2, "Current-based measurement"](#), on page 50
- Voltage-based measurement, see [Chapter 4.1, "Voltage-based measurement"](#), on page 49
- Measurements with external shunts or current probes, see [Chapter 4.4, "Connecting an external AC/DC shunt or clamp-on current probe"](#), on page 52.
- Internal wiring of the R&S NPA-Zx test adapter

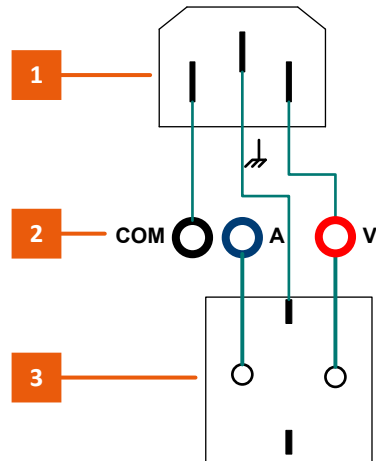

Figure 4-3: Internal wiring of A, V and COM of the R&S NPA-Zx

- 1 = AC power supply
- 2 = A, COM, V output connectors
- 3 = DUT power plug

To set up measurement with the R&S NPA-Zx

1. Inspect the connectors and the cables visually to check that they are clean, undamaged and mechanically compatible.

Note: If the visual inspection shows that a connector requires cleaning, see [Chapter 16.1, "Cleaning"](#), on page 252.

2. To connect the R&S NPA-Zx test adapter to the R&S NPA:



Figure 4-4: R&S NPA-Zx to R&S NPA measurement setup

3. Select the black cable.
4. Connect the COM connector of the R&S NPA to the COM connector of the R&S NPA-Zx.
5. Using the blue cable, connect the A connector of the R&S NPA with the A connector of the R&S NPA-Zx.
6. Connect the V connectors of both instruments with the red cable.

4.1 Voltage-based measurement

Used for measurements with high currents.

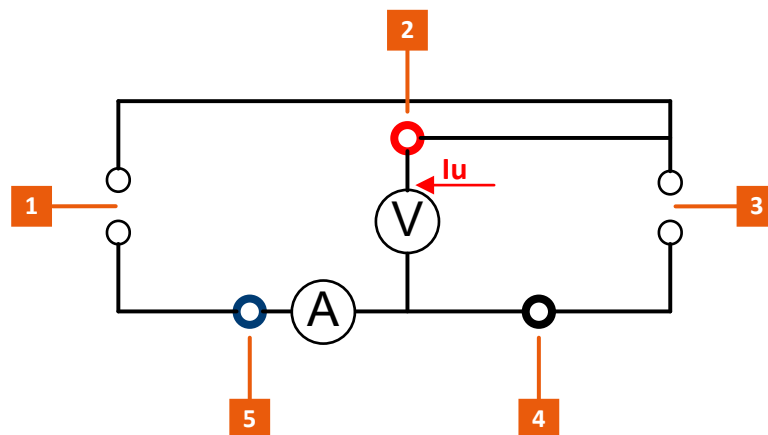

Figure 4-5: Voltage-based measurement circuit

- 1 = Mains (source)
- 2 = Current output A
- 3 = DUT (load)
- 4 = Common shared output COM
- 5 = Voltage output V

The voltage drop at the shunt increases with the current linearly. The measurement achieves a precise voltage reading at the load.



The measurement setup requires that you swap the A and COM inputs and invert the measured current reading.

To set up a voltage-based measurement with the R&S NPA-Zx

1. Inspect the connectors and the cables visually to check that they are clean, undamaged and mechanically compatible.
Note: If the visual inspection shows that a connector requires cleaning, see [Chapter 16.1, "Cleaning"](#), on page 252.
2. To connect the R&S NPA-Zx to the R&S NPA, consider that you swap the A and COM inputs:
 - a) **Black** cable: connect the **A** connector of the R&S NPA to the **COM** connector of the R&S NPA-Zx.
 - b) **Blue** cable: connect the **COM** connector of the R&S NPA with the **A** connector of the R&S NPA-Zx.
 - c) **Red** cable: connect the **V** connectors of both instruments.
3. On the R&S NPA, configure the measurement settings:
 - a) Press the [ACQ] key on the front panel.
 - b) In the acquisition softkey menu, press the "Current" softkey.
 - c) In the current softkey menu, select the "INVERT" key
 - d) Set "INVERT > On".
 - e) Press the [Back] key to return to full display of the measurement view.

4.2 Current-based measurement

Used for measurements with low currents and high voltages.

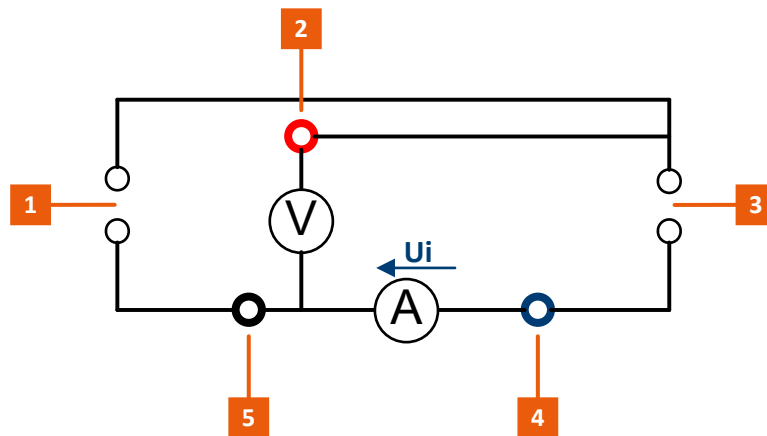

Figure 4-6: Current-based measurement circuit

- 1 = mains (source)
- 2 = voltage output V
- 3 = DUT (load)
- 4 = common shared output COM
- 5 = current output A

The current-based measurement prevents a current flow through the shunt, which would lead to impact of the readings at low currents.

To set up a current-based measurement with the R&S NPA-Zx

1. Inspect the connectors and the cables visually to check that they are clean, undamaged and mechanically compatible.

Note: If the visual inspection shows that a connector requires cleaning, see [Chapter 16.1, "Cleaning"](#), on page 252.

2. Connect the R&S NPA-Zx to the R&S NPA as described under "[To set up measurement with the R&S NPA-Zx](#)" on page 49.
3. On the R&S NPA, configure the measurement settings.

4.3 Connecting a DUT directly

For measurements with loads within the specified limits for voltage (up to 600 V_{rms}) and current (up to 20 A_{rms}), you can directly connect the DUT to the R&S NPA.

To connect a DUT directly

How to connect the DUT to the R&S NPA depends on the test setup.

1. Depending on the expected load, proceed as described for the corresponding test setup:
 - If you want to measure high currents, refer to [Chapter 4.2, "Current-based measurement"](#), on page 50.

Connecting an external AC/DC shunt or clamp-on current probe

- If you expect low currents, refer to [Chapter 4.1, "Voltage-based measurement"](#), on page 49.
2. To configure the measurement, see [Chapter 6, "Data acquisition"](#), on page 58.

For specifications, see the datasheet at www.rohdeschwarz.com/brochure-datasheet/npa.

4.4 Connecting an external AC/DC shunt or clamp-on current probe

Instrument models R&S NPA501(-G) and R&S NPA701(-G) enable you to use an external AC/DC current probe or shunt to measure the current and voltage of a DUT. For example, Rohde & Schwarz provides the clamp-on current probes R&S HZC50 and R&S HZC51. The clamp-on probes provide safety plugs you can directly connect to the instrument.

Measurements with clamp-on probes use the sensor connection to compensate voltage drops on the supply lines to the load.



Figure 4-7: R&S HZC51 clamp-on current probe

To connect the external clamp-on current probe

Instrument models R&S NPA501(-G) and R&S NPA701(-G) only

1. Inspect the connectors and the cables visually to check that they are clean, undamaged and mechanically compatible.

Note: If the visual inspection shows that a connector requires cleaning, see [Chapter 16.1, "Cleaning"](#), on page 252.

2. **DANGER!** Risk of electrical shock. Never use a BNC adapter to connect an external clamp-on current probe to the R&S NPA. Depending on the polarity of the voltage, the BNC plug coupling is live. Touching a live electrical device causes serious personal injury, or even death.

Align the cable connector of the probe with the colors matching to the "Sensor" connectors of the R&S NPA.

Connecting an external AC/DC shunt or clamp-on current probe

3. Plug the cable connector of the probe to the COM and the IN connectors of the R&S NPA.
4. To configure the measurement, see [Chapter 9.3, "Sensor settings"](#), on page 132.

5 Measurement parameters and ranges

5.1 Measurement parameters

The R&S NPA always derives all calculated parameters from the measurement, regardless of the selection on the screen. The following table shows all parameters available for display. Parameters that only apply to certain instrument models are pointed out. The columns to the right show the subsets of parameters available for certain functions only.

Table 5-1: List of measured and calculated parameters

Parameter	Description (unit)	Trendchart	Limit	Integrator
P	Active power (W)	x	x	
S	Apparent power (VA)	x	x	
Q	Reactive power (var)	x	x	
LAMBDA	Power factor λ		x	
PHI	Phase difference Phi (°)	x	x	
FU	Voltage frequency (Hz)	x	x	
FI	Current frequency (Hz)	x	x	
UPPeak ^{*)}	Maximum voltage (V)			
UMPeak ^{*)}	Minimum voltage (V)			
IPPeak ^{*)}	Maximum current (mA)			
IMPeak ^{*)}	Minimum current (mA)			
PPPeak ^{*)}	Maximum power (W)			
PMPeak ^{*)}	Minimum power (W)			
URMS	True RMS voltage (V) root mean square voltage	x	x	
UAVG	Average voltage (V)	x	x	
IRMS	True RMS current (mA) root means square current	x	x	
IAVG	Average current (mA)	x	x	
UTHD	Total harmonic distortion voltage (%)	x	x	
ITHD	Total harmonic distortion current (%)	x	x	
DIN ^{*)}	Digital input value (Hz)	x		
AIN ^{*)}	Analog input value (V)	x		
TIME	Integration time (00:00.0)			

Parameter	Description (unit)	Trendchart	Limit	Integrator
WH	Watt hour (mWh), sum of positive and negative watt hour			x
WHP	Positive watt hour (mWh)			x
WHM	Negative watt hour (mWh)			x
AH	Ampere hour(mAh) Sum of positive and negative ampere hour			x
AHP	Positive ampere hour (mAh)			x
AHM	Negative ampere hour (mAh)			x
Lim1..6 ^{*)}	Limit 1 to Limit 6 (%)			
URange	Range voltage (V) Voltage measurement range shown as bar graph			
IRange	Range current (mA) Current measurement range shown as bar graph			
FPLL	PLL source frequency (Hz) Phase locked loop synchronization frequency	x	x	
*)R&S NPA501(-G) / R&S NPA701(-G) only				

5.2 Measurement ranges

Each measurement requires, that you select the expected voltage and current measurement range before you start a measurement.

Regardless of the selected measurement mode and display, you can set the voltage and current measurement ranges directly with the keys on the front. The R&S NPA shows the settings in the status bar on the screen.

About

- The R&S NPA provides the function to adjust the voltage and current measurement ranges automatically, but also allows you to select each manually.
How to: see ["To set automatic measurement range"](#) on page 57 and ["To select a measurement range manually"](#) on page 56
- Automatic measurement range selection:
 - Thresholds:
If the measured value exceeds 120% of the set range, the instrument switches to the next higher range.
If the measured value is $\leq 95\%$ of the set range over a period of 0.6 s, the instrument switches to the next lower range.

- If the applied current exceeds the set range, the R&S NPA first switches to the maximum measurement range to protect the internal shunt from damage. In the next step, it adjusts the range accordingly.
Example:
Applied current: >2 A
Selected range: $\leq 200 \text{ mA} * 3$ (crest factor) = 600 mA
The R&S NPA sets the current range to 20 A, and then adjusts the range to 5 A.
- Automatic range selection disables manual range selection.
- Manual measurement range selection:
 - If the applied current value exceeds the maximum measurement range, the R&S NPA prompts an overload message.

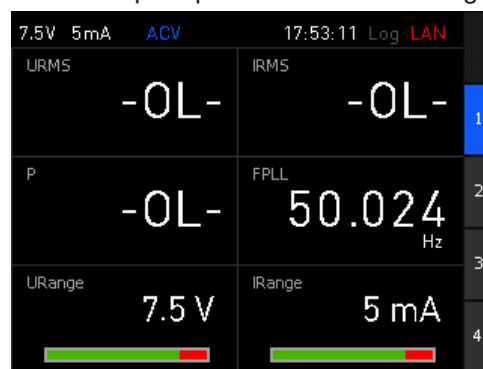

Figure 5-1: Example of OL display

A red measurement bar indicates that the applied signal exceeds the set range.

- Adjusting the range manually disables automatic range selection.
- Sensor measurement with an external clamp-on probe disables automatic current measurement mode, supported by (R&S NPA501(-G), R&S NPA701(-G), see [Chapter 4.4, "Connecting an external AC/DC shunt or clamp-on current probe"](#), on page 52

To select a measurement range manually

By default, automatic range is enabled, indicated in dark green in the status bar. To switch to manual selection of voltage and current measurement ranges, proceed as follows:

1. Press the [ACQ] key on the front panel.
2. Press the [U ▲] or key [U ▼] key, to switch to manual voltage range.
Alternatively, you can select the parameter and use the "AUTORANGE" softkey.
3. Press the [U ▲] key to increase the voltage range, or [U ▼] key to decrease it respectively.
4. Press the keys repeatedly until you have selected the range you need for your measurement.

The available settings depend on the crest factor, see [Table 6-1](#).

- Proceed the same way to select the current measurement range using the [I ▲] and [I ▼] keys.
The available settings depend on the crest factor, see [Table 6-2](#).
- To display the range graphically, assign the functions "URange" and "IRange" on the measurement page.
- How to: see "[To select parameters different from default display](#)" on page 109.



Figure 5-2: Graphical display of the measurement ranges

To set automatic measurement range

If automatic range is disabled, the R&S NPA indicates the parameter in the status bar in light green. You have several options, to set the automatic range:

- Press the [ACQ] key on the front panel.
- Using the function keys:
 - If automatic voltage range is disabled, press and hold either the [U ▲] or the [U ▼] key to switch to automatic mode.
 - Pressing one of the keys again returns to manual mode.For automatic current range selection, use the [I ▲] or the [I ▼] keys the same way.
- Using the acquisition settings:
 - Press the [ACQ] key.
 - Press the softkey of a parameter, e.g., the "Voltage" softkey.
 - Select "AUTORANGE" > "On".

6 Data acquisition

Acquisition modes

The R&S NPA acquires current and voltage readings simultaneously using a sampling frequency of 500 kSample/s. It refreshes the values displayed on the screen 10 times per second.

Provided acquisition modes:

- **DC**: Measures synchronized to 100 ms display update rate.
- **AC**: Measures synchronized to a voltage or current period.
- **AUTO**: Detects an incoming signal and selects the corresponding acquisition mode automatically.
- **EXTERN**: Measures synchronized to the external BNC connector (DIGITAL IN).

Crest factor

The crest factor represents the ratio of peak values to the effective values (RMS) of a waveform, i.e. an alternating signal.

This factor indicates how extreme peaks are in a waveform, which is important especially for the measurement of pulse-shaped sizes. For example, the ratio of $\sqrt{2}=1.414$ applies to pure sine wave types. The accuracy of the calculated effective value remains the same as long as the peak value is within the peak range.

To evaluate the waveform distortion of nonlinear electrical loads, you can use e.g., the waveform or trend chart mode, see [Chapter 8, "Display modes"](#), on page 107.

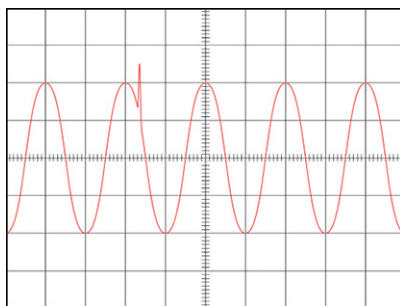

Figure 6-1: Sample configuration

Depending on the measurement, you can select a crest factor of 1, 3 or 6. Factor 6 is required, e.g. for measurements of sinusoidal waveforms with spikes or for standby measurements according to IEC 62018.

Invert function

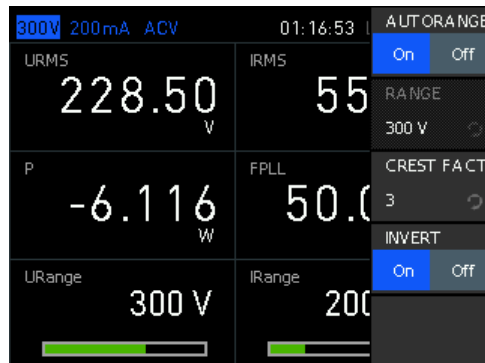

Figure 6-2: Inversion

In AC acquisition, the R&S NPA includes the sign of the measured parameters to derive the correct input or output values, e.g., the power value. Depending on the test setup, it can be necessary to measure a parameter inverted, as for e.g. for the [Voltage-based measurement](#), see page 49. This setup requires the wires to be swapped and thus also the measurement parameter to be inverted, see [Voltage Settings > Invert](#) and [Current Settings > Invert](#).

Filter

The R&S NPA features filter functions to increase the accuracy of the measurement:

- **Frequency filter**
500 Hz low-pass filter in the frequency path acquires the zero crossings to determine the signal period precisely. The filter does not affect the signal path.
- **Digital filter**
Calculates the average value of the filter setting over several periods. This function increases the accuracy and achieves more stability for fluctuating values.
- **BWL:**
1 kHz low-pass filter limits the bandwidth to generate a pure signal adjusted to RF.

You can enable the filters for [Acquisition modes "AC" and "AUTO"](#), see [Chapter 6.4, "Acquisition mode settings"](#), on page 68.

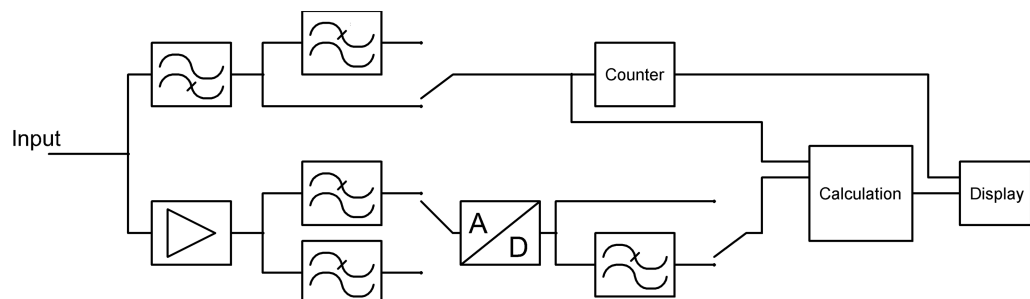

Figure 6-3: Filters arranged as a chain

Frequency source

The "PLL SRC" (Phase Locked Loop Source frequency synchronization) function sets the frequency of the fundamental wave as the reference value for the measured harmonics. By default, the R&S NPA refers to the voltage. However, measurements of signals with a small or irregular current trace achieve higher accuracy when you use a current as reference.

Access:

- ▶ Press the [ACQ] key on the front panel.

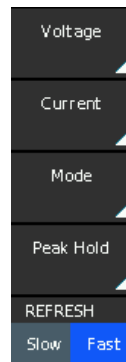

Figure 6-4: Acquisition softkey menu

The acquisition softkey menu contains the main parameters for configuring data acquisition.

To configure the voltage and current parameters

Voltage and current parameters are similar, therefore the example instruction summarizes the settings of both parameters.

To configure the range, crest factor and invert function:

1. Press the [ACQ] key.
2. Press, e.g., the "Voltage" softkey.
3. In the voltage softkey menu, select "AUTORANGE" > "Off".
4. Select the "RANGE" softkey.
5. Select the voltage range with the rotary knob, e.g. 300 V. Alternatively, you can press the "RANGE" softkey repeatedly to select the voltage range.

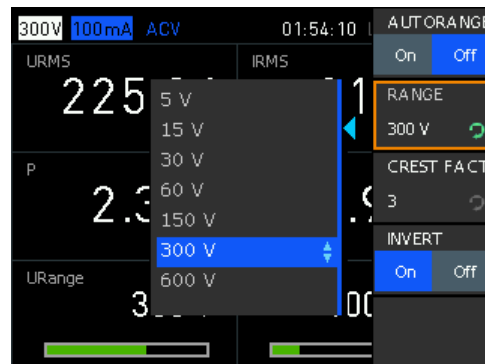

Figure 6-5: Select voltage range

6. Press the "CREST FACT" softkey to enable edit mode.
7. Select the crest factor by turning rotary knob, e.g., set "3".

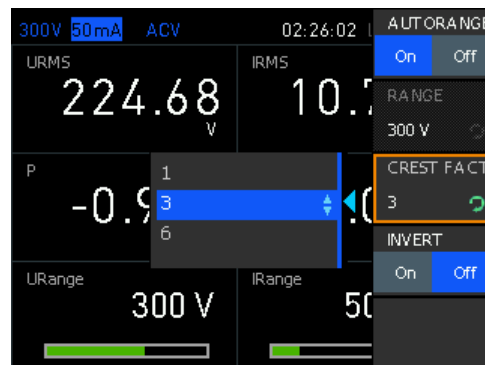



Figure 6-6: Select crest factor

8. Press the "INVERT" softkey, e.g. "Off".
9. Press the  key to return to the acquisition softkey menu.

To configure the acquisition mode

To configure the acquisition mode, e.g., select the AC mode and set the frequency synchronization and filters:

1. Press the [ACQ] key.
2. Press the "Mode" softkey.
3. In the mode softkey menu, select "MODE" to enable edit mode.

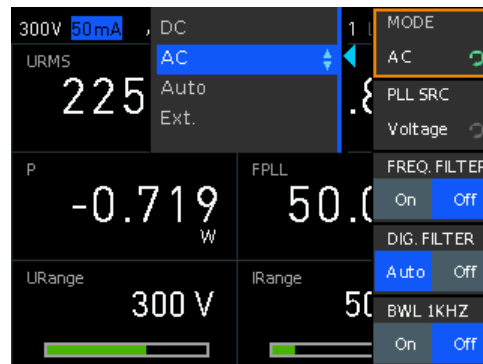

Figure 6-7: Select the parameter for data acquisition

4. Select, e.g., "AC" with the rotary knob.
5. Press the "PLL SRC" softkey repeatedly until you have selected "Voltage". Alternatively, you can use the rotary knob.

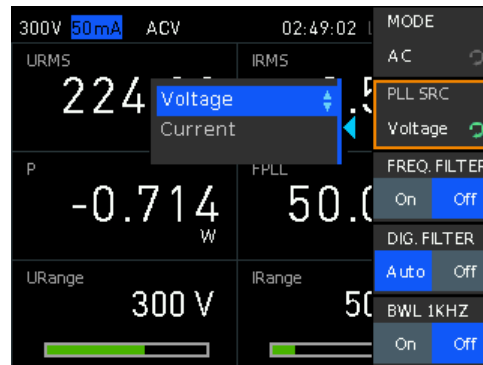



Figure 6-8: Select the PLL source

6. Set "FREQ. FILTER" > "On".
7. Set "DIG. FILTER" > "AUTO".
8. Set "BWL 1KHZ" > "On".
9. Press the  key to return to the acquisition softkey menu.

To enable the peak hold function and set the display update

Instrument models R&S NPA501(-G) and R&S NPA701(-G) support peak hold function only.

1. Press the [ACQ] key.
2. Press the "Peak Hold" softkey.

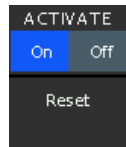

Figure 6-9: Enable peak hold



3. In the peak hold softkey menu, select "ACTIVATE" > "On".
4. Press the  key to return to the acquisition softkey menu.
5. Press the "REFRESH" softkey and select, e.g., "Fast" (toggle function).



Figure 6-10: Set refresh mode

6. Press the  key repeatedly to return to the acquisition softkey menu and to fold it down.

The R&S NPA shows the readings according to the settings.

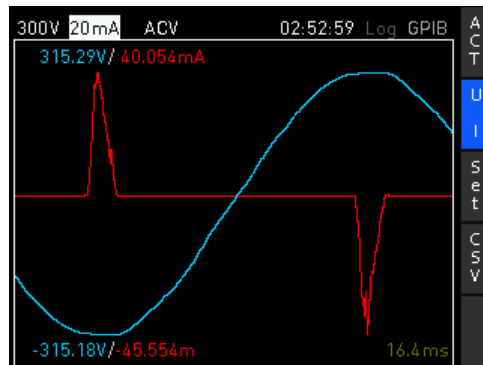

Figure 6-11: Example of AC acquisition with peak hold, inverted current and fast refresh

- 1 = voltage range (status bar)
- 2 = current, inverted
- 3 = mode AC -> voltage
- 4 = peak hold snapshot

- [Data acquisition settings](#)..... 64
- [Voltage settings](#)..... 65
- [Current settings](#)..... 67
- [Acquisition mode settings](#)..... 68
- [Peak hold settings](#)..... 70
- [Refresh settings](#)..... 71

6.1 Data acquisition settings

Access:

1. Press the [ACQ] key on the front panel.

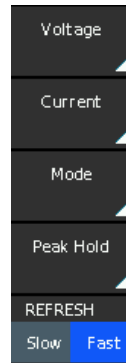

Figure 6-12: Acquisition softkey menu

2. Select the parameter to open the corresponding softkey menu.

The acquisition softkey menu contains the main parameters for configuring data acquisition.

The remote commands required to define these settings are described in [Chapter 13.3, "CHANnel:ACQuisition subsystem"](#), on page 188.

How to:

- ["To configure the voltage and current parameters"](#) on page 60
- ["To configure the acquisition mode"](#) on page 61
- ["To enable the peak hold function and set the display update"](#) on page 62

Settings

Voltage	64
Current	64
Mode	65
Peak Hold	65
REFRESH	65

Voltage

Opens the softkey menu for setting the voltage parameters, see [Chapter 6.2, "Voltage settings"](#), on page 65.

Remote command:

n.a.

Current

Opens the softkey menu for setting the current parameters, see [Chapter 6.3, "Current settings"](#), on page 67.

Remote command:
n.a.

Mode

Opens the softkey menu for selecting the data acquisition mode, see [Chapter 6.4, "Acquisition mode settings"](#), on page 68.

Remote command:
n.a.

Peak Hold

Opens the peak hold softkey menu, see [Chapter 6.5, "Peak hold settings"](#), on page 70.

Remote command:
n.a.

REFRESH

Selects the update rate for the result display, see [Chapter 6.6, "Refresh settings"](#), on page 71.

Remote command:
n.a.

6.2 Voltage settings

Access:

1. Press the [ACQ] key on the front panel.
2. Press the "Voltage" softkey.



Figure 6-13: Voltage softkey menu

How to: see ["To configure the voltage and current parameters"](#) on page 60.

Settings

AUTORANGE	66
RANGE	66
CREST FACT	66
INVERT	66

AUTORANGE

Starts the automatic adjustment of the voltage range.

Remote command:

[CHANnel\[:ACQuisition\]:VOLTage:RANGe:AUTO](#) on page 196

RANGE

If [AUTORANGE = OFF](#), selects the voltage range manually. The available range settings depend on the selected crest factor, see "[CREST FACT](#)" on page 66.

Table 6-1: Available voltage range settings

Crest factor 1	Crest factor 3	Crest factor 6
15 V	5 V	2.5 V
45 V	15 V	7.5 V
90 V	30 V	15 V
180 V	60 V	30 V
450 V	150 V	75 V
900 V	300 V	150 V
1.8 kV	600 V	300 V

Remote command:

[CHANnel\[:ACQuisition\]:VOLTage:RANGe](#) on page 196

CREST FACT

Selects the crest factor for the voltage measurement.

Available settings: "1", "3", "6".

Remote command:

[CHANnel\[:ACQuisition\]:VOLTage:CFACTor](#) on page 196

INVERT

Inverts the sign of the voltage reading.

This setting is necessary for certain test setups, see [Chapter 4, "Measurement setups"](#), on page 47.

Remote command:

[CHANnel\[:ACQuisition\]:VOLTage:INVert](#) on page 196

6.3 Current settings

Access:

1. Press the [ACQ] key on the front panel.
2. Press the "Current" softkey.



Figure 6-14: Current softkey menu

How to: see ["To configure the voltage and current parameters"](#) on page 60.

Settings

AUTORANGE	67
RANGE	67
CREST FACT	68
INVERT	68

AUTORANGE

Activates the automatic adjustment of the current range.

Remote command:

[CHANnel\[:ACquisition\]:CURRent:RANGe:AUTO](#) on page 193

RANGE

If [AUTORANGE = OFF](#), selects the current range manually. The available range settings depend on the selected crest factor, see ["CREST FACT"](#) on page 68.

Table 6-2: Available current range settings

Crest factor 1	Crest factor 3	Crest factor 6
15 mA	5 mA	2.5 mA
30 mA	10 mA	5 mA
60 mA	20 mA	10 mA
150 mA	50 mA	25 mA
300 mA	100 mA	50 mA

Crest factor 1	Crest factor 3	Crest factor 6
600 mA	200 mA	100 mA
1.5 A	500 mA	250 mA
3 A	1 A	500 mA
6 A	2 A	1 A
15 A	5 A	2.5 A
30 A	10 A	5 A
60 A	20 A	10 A

Remote command:

[CHANnel\[:ACQuisition\]:CURRent:RANGe](#) on page 193

CREST FACT

Selects the crest factor for the current measurement.

Available settings: "1", "3", "6".

Remote command:

[CHANnel\[:ACQuisition\]:CURRent:CFACtor](#) on page 192

INVERT

Turns the sign of the current reading.

This setting is necessary for certain test setups, e.g. [Chapter 4.1, "Voltage-based measurement"](#), on page 49.

Remote command:

[CHANnel\[:ACQuisition\]:CURRent:INVert](#) on page 192

6.4 Acquisition mode settings

Access:

1. Press the [ACQ] key on the front panel.

2. Press the "Mode" softkey.



Figure 6-15: Acquisition mode softkey menu

The acquisition mode softkey menu enables you to select the acquisition parameter, and to configure the frequency synchronization and filters.

Settings

Mode.....	69
PLL SRC.....	69
FREQ FILTER.....	69
DIG. FILTER.....	70
BWL 1KHZ.....	70

Mode

Selects the data acquisition mode.

"DC"	Sets the mode to measure synchronized to 100 ms display update rate.
"AC"	Sets the mode to measure synchronized to a voltage or current period. To set the synchronization frequency, see "PLL SRC" on page 69).
"AUTO"	Sets the acquisition mode for the incoming signal automatically.
"EXT"	Sets the acquisition mode for measuring an externally applied signal. The measurement requires synchronization with the external signal.

Remote command:

`CHANnel[:ACquisition]:MODE` on page 194

PLL SRC

Selects the signal source for the synchronization frequency in acquisition **MODE AC**.

See "Frequency source" on page 60.

Remote command:

`CHANnel[:ACquisition]:MODE[:AC]:PLL` on page 194

FREQ FILTER

Enables the frequency filter.

See "Filter" on page 59.

Remote command:

`CHANnel[:ACQuisition]:MODE[:FILTer]:FREQuency` on page 195

DIG. FILTER

Enables the digital filter.

See "Filter" on page 59.

Remote command:

`CHANnel[:ACQuisition]:MODE[:FILTer]:DIGital` on page 195

BWL 1KHZ

Enables the 1 kHz low-pass filter.

See "Filter" on page 59.

Remote command:

`CHANnel[:ACQuisition]:MODE[:FILTer]:ANALog` on page 194

6.5 Peak hold settings

The "PEAK HOLD" function acquires and displays the maximum peak values over all measurement traces, providing a reliable measured value for the evaluation of the connected load. It displays the readings until a new measurement starts, or you reset or deactivate the function.

If the R&S NPA indicates "OL", i.e. the value exceeds the maximum, you can reset the display. The setting does not affect the data acquisition.

Access:

1. Press the [ACQ] key on the front panel.
2. Select the "Peak Hold" softkey.



Figure 6-16: Peak hold softkey menu

The softkey menu enables you to activate the function and reset the peak values.

How to: see "To enable the peak hold function and set the display update" on page 62.

Activate

Starts peak hold monitoring.

Remote command:

`CHANnel[:ACQuisition]:PEAKhold:ACTivate` on page 195

Reset

Resets the peak hold values.

Remote command:

[CHANnel\[:ACquisition\]:PEAKhold:RESet](#) on page 195

6.6 Refresh settings

Refresh determines the update rate of the measured values displayed in [numeric display](#) mode. The R&S NPA continuously updates the display either fast, indicating the current readings, or at a slow rate, indicating the average values of the last 10 readings.

Access:

1. Press the [ACQ] key on the front panel.
2. Select the "REFRESH" softkey.

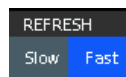

Figure 6-17: Data acquisition refresh softkey

How to: see ["To enable the peak hold function and set the display update"](#) on page 62.

REFRESH

Selects the update rate for the result display.

Fast	Refreshes the display 10 times per second, indicating the currently measured values.
Slow	Reduces the refresh rate to 1 update per second and displays the average values of the last 10 readings. The display in slow refresh rate does not affect the data acquisition.

Remote command:

n.a.

7 Measurement modes

When a measurement is activated, the R&S NPA measures continuously and updates the display in regular intervals. Depending on the selected view and measurement mode, the display provides the corresponding results either numerically, or graphically.

The following sections describe the measurement modes and views of the R&S NPA, and explain the corresponding parameters regarding the corresponding remote control commands.

7.1 Integrator

The R&S NPA derives the integrator values WHP, WHM, AHP and AHP based on the measured values. Using this function, you can measure the energy consumption of electronic devices with fluctuating power consumption. WHP and AHP represent the positive power and current, and WHM, AHM the corresponding negative values. WH and AH correspond to the sum of the positive and negative parts of watt-hours and ampere-hours.

Example: Measuring the energy consumption of a battery

A battery that is charged with 4 Ah and discharged with 1 Ah.

5V 2A DC 31:46.0 Log LAN		
TIME	31:46.0	UAVG 3.3091 V
P	-3.309 W	I AVG -0.9999 A
WH	8.8082 Wh	AH 2.9997 Ah
WHP	12.193 Wh	AHP 4.0005 Ah
WHM	-3.3853 Wh	AHM -1.0008 Ah

Figure 7-1: Example of integrator output values

Result: AH = AHP - AHM = 4.0005 Ah - 1.0008 Ah = 2.9997 Ah, as shown on the screen.

Access:

1. Press the [MEAS] key on the front panel.

- Press the "Integrator" softkey.

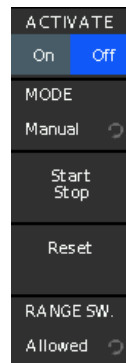

Figure 7-2: Integrator softkey menu

The softkey menu contains basic parameters for configuring integrator measurements.

The remote commands required to define these settings are described in [Chapter 13.11, "INTEgrator subsystem"](#), on page 218.

To select the parameters for display

The following instructions refer to the example above, e.g., to select the integration time, and the watt-hour / ampere-hour parameters, see [Example "Measuring the energy consumption of a battery"](#) on page 72.

- To select the measurement page, press, e.g., the "1" softkey.

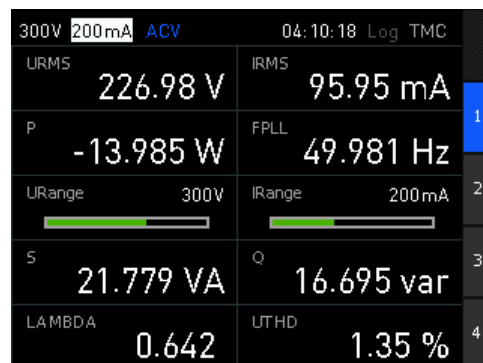

Figure 7-3: Display of 10 parameters

The screen display toggles to the window indicating 10 parameter fields.

- Press the [rotary knob].

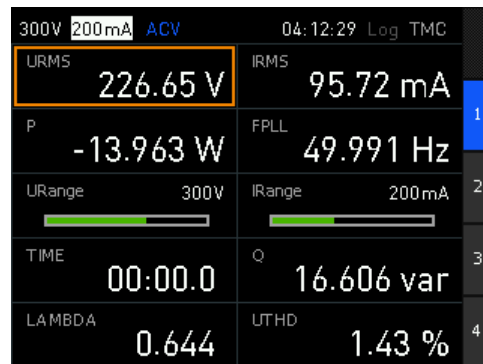

Figure 7-4: Parameter selection enabled

Usually, the first parameter field on the screen changes in edit mode, indicated by the orange frame.

3. Select the parameter field you want to assign a parameter with the rotary knob or the arrow keys.
4. Press the [rotary knob].
5. In the parameter list, select e.g., "TIME" with the rotary knob.

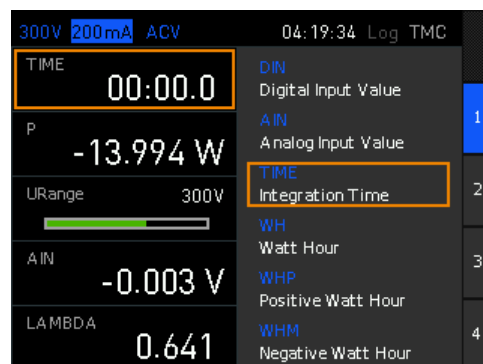

Figure 7-5: Parameter selection

6. Press the rotary knob to confirm the selection.
7. Repeat [step 2](#) to [step 6](#) until you have assigned the WH, WHP, WHM, AH, AHP and AHM parameters to the screen.

To configure an integrator measurement in manual mode

The following example shows how to configure an integrator measurement manually:

1. Configure a measurement page as described in ["To select the parameters for display"](#) on page 73.
2. To access the integrator softkey menu, select [MEAS] > "Integrator".
3. In the integrator softkey menu, press the "MODE" softkey.



Figure 7-6: Integrator mode selection

4. Select "Manual" using the rotary knob.
5. Press the [RANGE SW.] softkey.
6. Select "Allowed" to allow range switching.



Figure 7-7: Range switching selection

7. Select "ACTIVATE" > "On".
8. Start the measurement with the [START/STOP] key on the front panel, or the "Start Stop" softkey.

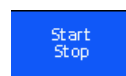

Figure 7-8: Start/Stop softkey

The R&S NPA measures the energy use of the DUT and records the readings. The status bar shows the integration time.

9. To stop the measurement, press the [START/STOP] (toggle function).
10. To reset the readings, press the [RESET] key.

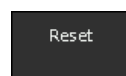

Figure 7-9: Integrator reset softkey

To configure the integrator mode span

The following example shows how to configure an integrator measurement in span mode:

1. Configure a measurement page as described in ["To select the parameters for display"](#) on page 73.
2. To access the integrator softkey menu, select [MEAS] > "Integrator"
3. In the integrator softkey menu, press the "MODE" softkey.
4. Select "Span" using the rotary knob.

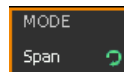

Figure 7-10: Integrator mode span

5. Press the "Start Time" softkey.

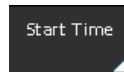

Figure 7-11: Start time in span mode

6. You have two options to set the start time:
 - a) To set a specific time, proceed the same way as described in ["To set date and time of the instrument internal clock"](#) on page 29
 - b) To start the measurement immediately, press the "Set to curr. time" softkey.



Figure 7-12: Current time softkey

7. Press the "Duration" softkey.

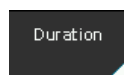



Figure 7-13: Duration softkey

8. Set the measurement time interval with the corresponding softkeys and the rotary knob.



Figure 7-14: Duration interval setting

- a) Press the "Hour" softkey to enable edit mode.
 - b) Set how many hours you want to measure with the rotary knob.
 - c) Press the rotary knob to confirm the setting.
 - d) Set the duration for minutes and seconds the same way.
9. Press the  key to return to the integrator softkey menu.
 10. Select "ACTIVATE" > "On" to start the measurement.

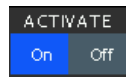

Figure 7-15: Start measurement

The measurement starts at the set time and stops when the duration time has elapsed.

To configure integrator mode duration

The following example shows how to configure an integrator measurement in duration mode:

1. Configure a measurement page as described in ["To select the parameters for display"](#) on page 73.
2. To access the integrator softkey menu, select [MEAS] > "Integrator"
3. In the integrator softkey menu, press the "MODE" softkey.
4. Select "Duration" using the rotary knob.

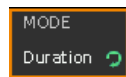

Figure 7-16: Integrator mode duration

5. Press the "Duration" softkey to set the duration time interval.

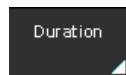

Figure 7-17: Duration softkey

6. Proceed as described in [step 8](#).
7. Press the  key to return to the integrator softkey menu.
8. Select "ACTIVATE" > "On".



Figure 7-18: Start measurement

9. Start the measurement with the [START/STOP] key on the front panel, or the "Start Stop" softkey.

The R&S NPA measures the energy use of the DUT and records the readings. The status bar shows the integration time.

The measurement starts at the set time and stops when the duration time has elapsed.

To configure an external integrator mode

The following example shows how to configure an externally triggered integrator measurement.

1. Assign an external trigger signal at the DIGITAL IN connector.
2. Configure a measurement page as described in ["To select the parameters for display"](#) on page 73.
3. To access the integrator softkey menu, select [MEAS] > "Integrator"
4. In the integrator softkey menu, press the "MODE" softkey.
5. Select "Extern" using the rotary knob.

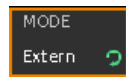

Figure 7-19: Integrator mode extern

6. Select "ACTIVATE" > "On".

The measurement starts triggered by the high pulse of the external signal, and stops when the signal switches to a low level.

Settings

Activate	78
Mode	78
Start Stop	79
Reset	79
Start Time	79
L Set to curr. time	79
L Set Date & Time	80
Duration	80
RANGE SW	80

Activate

Starts the integrator measurement.

Depending on the operating mode, the integrator is a precondition for starting a measurement.

Remote command:

[INTegrator\[:STATe\]](#) on page 222

Mode

Selects the integrator mode.

The R&S NPA starts the measurement depending on the selected mode, and when you [Activate](#) the integrator.

"Manual"	Starts the integrator measurement manually triggered with Start Stop . To stop the measurement, press the "START/STOP" softkey again (toggle function).
"Span"	Measures within a defined time interval, set with "Start Time" on page 79 and "Duration" on page 80. Integration measurement starts at the set start time. It stops after the time span has elapsed.
"Duration"	Measures within a defined time span. To set the time period, see "Duration" on page 80. Integration measurement starts immediately with ACTIVATE > On . It stops after the time span has elapsed.
"Extern"	Triggers the measurement with an external pulse signal. To assign the signal, use the external BNC connector (DIGITAL IN). Integration measurement starts with a "high" pulse of the digital signal. The measurement stops when the external signal is "low".

Remote command:

[INTegrator:MODE](#) on page 221

Start Stop

Starts and stops the integration measurement in the integrator [Mode > Manual](#).

Remote command:

[INTegrator:START](#) on page 221

[INTegrator:STOP](#) on page 222

Reset

Resets the integration time and values when you have executed the integration measurement manually, i.e. in integrator [Mode > Manual](#) or [Mode > Extern](#).

The R&S NPA indicates the integration time in the status line of the display.

Remote command:

[INTegrator:RESet](#) on page 221

Start Time

Opens the softkey menu with time setting parameter for integrator [Mode > Span](#).

Remote command:

[INTegrator:STIME](#) on page 222

Set to curr. time ← Start Time

Uses the time stamp of the instrument internal date and time for the integration measurement [Mode > Span](#).

To adjust the internal data and time setting, see [Chapter 11.3.2, "Date and time"](#), on page 151.

Remote command:

[INTegrator:STIME](#) on page 222

Set Date & Time ← Start Time

Opens the "Set Date & Time" function to configure a date and time stamp in the integrator [Mode > Span](#).

How to: see [Chapter 3.1.12, "Configuring the initial instrument settings"](#), on page 29.

Remote command:

`INTEgrator:STIME` on page 222

Duration

Opens the softkey menu with time setting parameters for integrator [Mode > Span](#) or [Mode > Duration](#).

The maximum duration is 96 hours.

"HOUR" Sets number of hours.

"MIN" Sets the minutes.

"SEC" Sets the seconds.

Remote command:

`INTEgrator:DURation` on page 220

RANGE SW.

Sets the state for range switching during the integrator measurement.

"Allowed" Enables range switching.
The R&S NPA does not record any value during the switching time.

"Blocked" Blocks range switching.

Remote command:

n.a.

7.2 Data logging

The logging function enables you to record the measurement data. You can save the readings on the internal memory of the R&S NPA or on an externally connected USB flash drive. The function provides the file formats `.csv` or `.txt`, with user-definable file name.

Aspects on the logging function:

- The R&S NPA does not support external USB hard drives (or USB extensions). We recommend that you use USB flash drives with FAT/FAT32 formatting (4 Gbyte max.). The instrument recognizes the USB device automatically.
- The maximum logging duration is 96 hours ("DURATION").
- When running, the instrument indicates a green "LOG" label in the status bar. When disabled, the label color is white.

Access:

1. Press the [MEAS] key on the front panel.

- In the measurement softkey menu, press the "Logging" softkey.

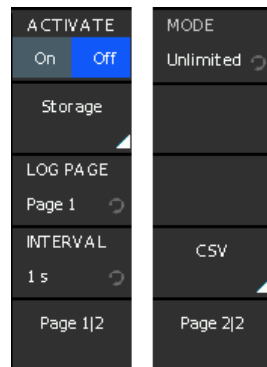

Figure 7-20: Logging softkey menu

The softkey menu contains basic parameters for setting the logging mode, and provides access to file management parameters.

To select the measurement parameters

- Select the parameters that you want to record as described in ["To select parameters different from default display"](#) on page 109.
- To start the measurement, see ["To start the measurement"](#) on page 37.

To configure the file storage settings

E.g., configure the storage location, file name and file format:

- Press the [MEAS] key.
- Press the "LOGGING" softkey.
- Press the "Storage" softkey.



Figure 7-21: Logging storage softkey

The R&S NPA opens a softkey menu where you can define the file name and storage location.



Figure 7-22: Storage softkey menu

4. Select "STORAGE" to open the dialog for managing the memory location. In the "TARGET DIRECTORY" dialog, you can create, define or delete directories as known from common file managers.

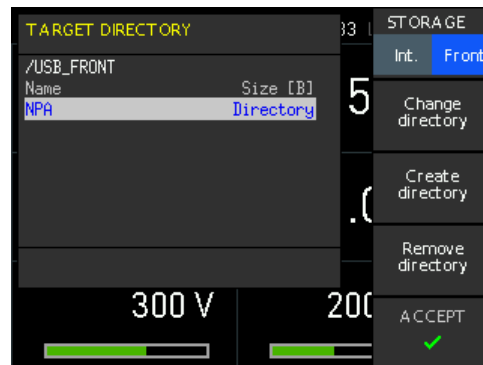



Figure 7-23: Storage settings

Tip: Managing the directories is only available for the external memory.

5. Plug in a USB memory stick, if you want to save the logging data in the external memory.
6. Select the memory location, e.g. "Front".
7. Press the "Change directory" softkey, to navigate to the target directory (toggle function).
8. To create a directory, press the "Create directory" softkey. A standard editor opens to assign a directory name.
 - a) Enter the directory name using the rotary knob.
 - b) Confirm with "Accept".
 - c) Use the rotary knob to select the new created target directory.
9. Press the "Remove directory" if you want to delete a subdirectory. Proceed the same way as described for creating a directory.
10. Select the "FILE NAME" softkey.
11. Enter the file name by selecting the digits with the rotary knob.

12. Press the rotary knob to confirm each digit.
 - Note:** The length of the file name is limited to 8 digits.
13. When completed, select "Accept" to confirm your entry.
14. Press the  key to return to the "Logging" softkey menu.

To configure data logging

Prepare data acquisition and configure the data logging parameters:

1. Connect a USB device to the USB connector on the [front](#), see "USB A" on page 34.
2. Press the [MEAS] key.
3. In the measurement softkey menu, press the "LOGGING" softkey.
4. Select the "LOG PAGE" softkey to enable edit mode.

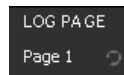

Figure 7-24: Logging page softkey

The R&S NPA opens a

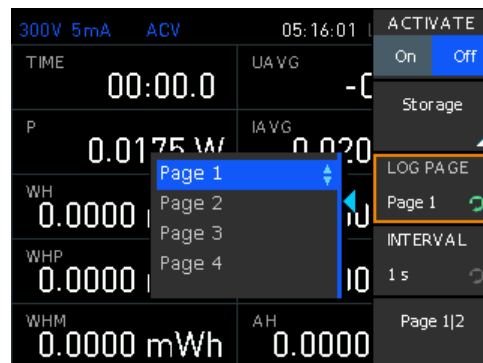

Figure 7-25: Logging page selection

5. Select the page with the measurement parameters you want to record.
6. Select "INTERVAL" to determine the time period.

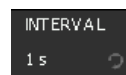

Figure 7-26: Logging interval softkey

The R&S NPA opens a selection list with the available time interval settings.

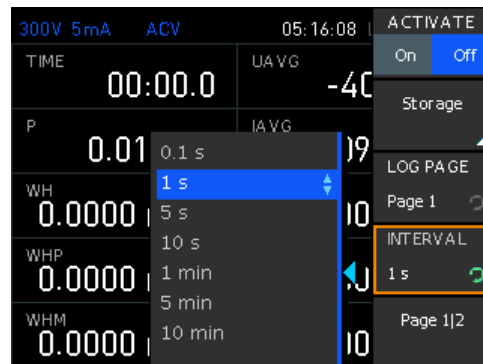

Figure 7-27: Logging interval selection

7. Select the corresponding time with the rotary knob.
8. On page 2 of the softkey menu, select the data logging mode.

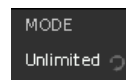

Figure 7-28: Logging mode softkey

9. Depending on the selected mode, the softkey menu varies and displays the setting parameters required to configure the selected mode.

Example: If you have selected "MODE > Span", you must configure the start time and duration of the time span.

How to: proceed as also described for measurement mode [Chapter 7.1, "Integrator"](#), on page 72.

To configure the data format

Configure the measurement readings in the data log file:

1. Press the [MEAS] key.
2. In the measurement menu, select the "LOGGING" softkey.
3. On page 2 of the softkey menu, select "CSV".
4. Set the field and line separators for the format of the file content.
5. When completed, press the [MEAS] key.

Note: As "CSV" is a general function for all data formats, it leads you to the general settings of the instrument. Therefore, the  key returns to the next higher menu level of the general settings.

To continue with data logging, open the function again with the [MEAS] key and the "Logging" softkey.

To start data recording

- ▶ Select "ACTIVATE" > "On".



Figure 7-29: Start logging

To stop data recording

There are several options that stop the data logging function:

- ▶ Select "ACTIVATE" > "Off".



Figure 7-30: Stop logging

Stops data logging at any time, independently of the set mode.

- Data logging mode "Duration" stops data recording when the time span has elapsed.

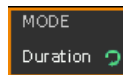

- Data logging mode "Span" stops data recording when the time span has elapsed.

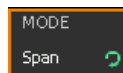

- Data logging mode "MODE > Count" stops recording when the number of measurement readings is reached.

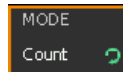

Figure 7-31: Logging mode count

- Data logging mode "Unlimited" records data continuously until you stop it manually. It aborts automatically when the memory size is reached.

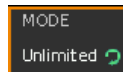

Figure 7-32: Logging mode unlimited

7.2.1 Data logging settings

The "Logging" softkey menu enables you to configure the main parameter settings for data logging.

Access:

1. Press the [MEAS] key on the front panel.
2. In the measurement softkey menu, press the "Logging" softkey.

The remote commands required to define these settings are described in [Chapter 13.12, "LOG subsystem"](#), on page 223.

How to: ["To configure data logging"](#) on page 83

Settings

ACTIVATE.....	86
Storage.....	86
LOG PAGE.....	86
INTERVAL.....	86
Page 1 2 / Page 2 2.....	86
MODE.....	86
COUNT.....	87
Duration.....	87
Start Time.....	87
L Set to curr. time.....	87
L Set Date & Time.....	88

ACTIVATE

Starts data acquisition and saving of the readings.

Remote command:

[LOG\[:STATe\]](#) on page 227

Storage

Opens the storage settings menu, see [Chapter 7.2.2, "Storage settings"](#), on page 88.

Remote command:

n.a.

LOG PAGE

Selects the measurement readings page for recording.

You can configure and arrange the parameters of a measurement readings page individually.

How to: [Chapter 8.1, "Numeric view"](#), on page 108.

Remote command:

[LOG:PAGE](#) on page 226

INTERVAL

Selects the time period for data logging.

The parameter interval specifies the time between the recorded measurement values.

Remote command:

[LOG:INTerval](#) on page 226

Page 1|2 / Page 2|2

The "Page 1|2" softkey toggles between the pages of the "Logging" softkey menu.

MODE

Selects a logging mode.

"Unlimited"	Records data continuously, without a time limit. Data logging starts immediately with Activate > On . The amount of recorded data is limited by the size of the storage memory.
"Count"	Records a defined number of measurement readings. To determine the number, see "COUNT" on page 87. Data logging starts immediately with Activate > On . It stops when the number of readings is reached.
"Duration"	Records measurement readings within a defined time span. To set the time period, see "Duration" on page 87. Data logging starts immediately with Activate > On . It stops after the time span has elapsed.
"Span"	Records measurement readings from a certain start time for a defined time span. To set the parameter, see "Start Time" on page 87. Data recording starts at the start time and with Activate > On . It stops automatically after the time span has elapsed.

Remote command:

[LOG:MODE](#) on page 226

COUNT

Sets the number of measurement readings for data logging [Mode > Count](#).

Remote command:

[LOG:COUNT](#) on page 225

Duration

Opens the softkey menu with time setting parameters for data logging [Mode > Duration](#) or [Mode > Span](#).

The maximum logging duration is 96 hours.

"HOUR" Sets number of hours.

"MIN" Sets the minutes.

"SEC" Sets the seconds.

Remote command:

[LOG:DURation](#) on page 225

Start Time

Opens the softkey menu with time setting parameter for data logging [Mode > Span](#) or [Mode > Duration](#).

Remote command:

[LOG:STIME](#) on page 227

Set to curr. time ← Start Time

Uses the time stamp of the instrument internal date and time for data logging [Mode > Span](#).

To adjust the internal data and time setting, see [Chapter 11.3.2, "Date and time"](#), on page 151.

Remote command:

[LOG:STIME](#) on page 227

Set Date & Time ← Start Time

Opens the "Set Date & Time" function to configure a date and time stamp for the recorded data in logging [Mode > Span](#).

How to: see [Chapter 3.1.12, "Configuring the initial instrument settings"](#), on page 29.

Remote command:

[LOG:STIME](#) on page 227

7.2.2 Storage settings

In the "Storage" softkey menu, you can select the memory location and assign the file name for data logging files.

Access:

1. Press the [MEAS] key on the front panel.
2. In the measurement menu, select the "LOGGING" softkey.
3. Press the "Storage" softkey.

The remote command required to set filename, path and storage location is [LOG:FNAMe](#) on page 225.

How to: ["To configure the file storage settings"](#) on page 81

Settings

STORAGE	88
L Change directory	88
L Create directory	89
L Remove directory	89
L Accept	89
Filename	89
Browser	89

STORAGE

Selects the memory drive.

- | | |
|------------|---|
| "Internal" | Saves the file in the internal memory. |
| "Front" | Saves the data to an external USB memory device.
The connector is on the front . |

Change directory ← STORAGE

Navigates between the available directories one level up or down, starting from the currently selected directory.

Create directory ← STORAGE

Opens a keypad for entering the directory name.

Remove directory ← STORAGE

Deletes a directory from the memory device.

The R&S NPA prompts you to confirm the action.

Accept ← STORAGE

Confirms the settings and returns to the "STORAGE" softkey menu.

Filename

Opens a keypad for entering the file name.

Browser

Opens a keypad for entering the file name.

How to: ["Entering alphanumeric data"](#) on page 45.

7.2.3 File format settings

The "CSV" softkey provides access to the standard "CSV" softkey menu. In the CSV menu, you can define the table separators and decimal floating points for data.

Access:

1. Press the [MEAS] key on the front panel.
2. In the measurement menu, press the "LOGGING" softkey.
3. Press the "PAGE 1|2" softkey.
4. Press the "CSV" softkey.



Figure 7-33: CSV softkey

The instrument opens a softkey menu with the data format settings, described in [Chapter 11.3.7, "CSV"](#), on page 157.

7.2.4 Evaluating logged data

For the analysis of the measurement results, you can use any spreadsheet program that supports *.csv or .txt file format and graphical representation also.

For details on the file format, see [Chapter 11.3.7, "CSV"](#), on page 157.

This section deals with a recorded measurement example. It shows the contents of the log file, describes how to load the file into a program and how to represent the data when using the Microsoft®EXCEL application.

Example: Data format of a data logging file

The content in the log starts with meta data, which contains a unique identifier of the instrument, information on date, and measuring and duration, and the settings of the measurement. The following character string lists the measurement parameter names and the corresponding measured values, separated by customizable separators.

```
#Device;NPA701
#Device Name;PM
#Format;LOG
#Date;2020-01-01
#Version;00.021-02.430-03.730
#Serial No.;012345678
#Mode;Count
#Logging Interval[s];1.000
#Specified Logging Count;1800
#Specified Logging Time[s];-----
#Start Time;04:49:33
#Stop Time;04:49:37
#Actual Count;4

URMS [V]; IRMS [A]; P [W]; FU [Hz]; EMPTY; EMPTY; S [VA]; Q [var]; LAMBDA []; UTHD [%]; Timestamp
231.27E+00; 45.0E-03; 6.63E+00; 50.0E+00; nan; nan; 10.38E+00; 7.98E+00; 639E-03; 2E+00;
04:49:33:000
231.38E+00; 45.0E-03; 6.64E+00; 50.0E+00; nan; nan; 10.38E+00; 7.98E+00; 639E-03; 2E+00;
04:49:34:000
231.35E+00; 45.0E-03; 6.63E+00; 50.0E+00; nan; nan; 10.38E+00; 7.98E+00; 639E-03; 2E+00;
04:49:35:000
231.38E+00; 44.9E-03; 6.63E+00; 50.0E+00; nan; nan; 10.38E+00; 7.99E+00; 639E-03; 2E+00;
04:49:36:000
```

If a log file contains empty cells, denoted with "nan" (not a number), consider the information provided in [Chapter 11.3.7, "CSV"](#), on page 157.

To import the log file to Microsoft®EXCEL

You can open the file in the application and convert the text format to a table format. As Microsoft®EXCEL is a common PC application, we assume basic knowledge of handling. The description shows only briefly how to set the separators to generate a table from the measured values.

1. Connect the USB memory device to the PC.
2. Open the application.
3. In the "Data" tab, select "From text".
4. Select the *.csv log file.
5. Confirm with "Import".

The "Text import Wizard" opens leading you through the steps to be taken.

6. Follow the instructions of the wizard.

When completed, you can adjust the formatting of the table as required and use the graphical options of the application for analyzing and evaluating the measurement series.

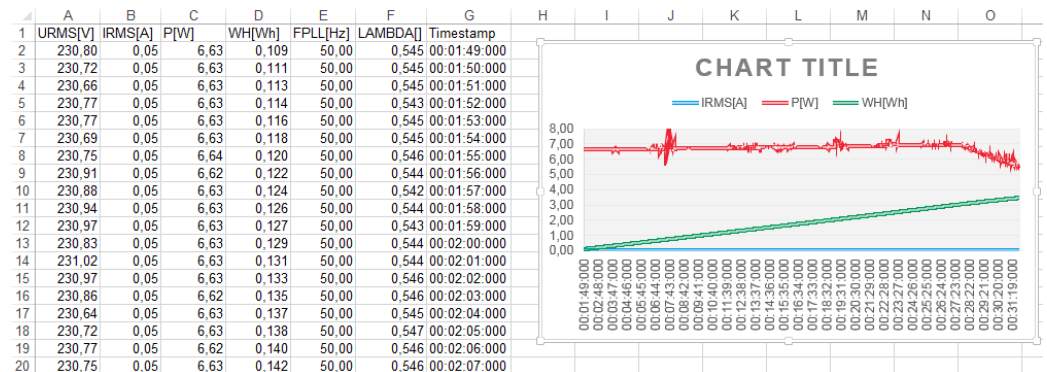

Figure 7-34: Graphical log file analysis

7.3 Limit

Instrument models R&S NPA501(-G) and R&S NPA701(-G) only

The limit measurement function allows you to define limit values for up to six parameters. The available parameters are listed in [Table 7-1](#). You can select up to 6 parameters individually, and determine the minimum and maximum limit for each selected parameter.

Table 7-1: List of parameters that can be limited

Parameter	Description (unit)
P	Active power (mW)
S	Apparent power (VA)
Q	Reactive power (var)
LAMBDA	Power factor (λ)
PHI	Phase shift (φ)
F _U	Frequency value for the voltage (Hz)
F _I	Frequency value for the current (Hz)
FPLL	Phase locked loop synchronization frequency (Hz)
U _{rms}	Root mean square voltage (V)
U _{AVG}	Average voltage (V)
I _{rms}	Root mean square current (mA)
I _{AVG}	Average current (mA)

Parameter	Description (unit)
U_{THD}	Total harmonic distortion voltage (%)
I_{THD}	Total harmonic distortion current (%)

Access:

1. Press the [MEAS] key on the front panel.
2. Press the "Limit" softkey.



Figure 7-35: Limit softkey menu

The remote commands required to define these settings are described in [Chapter 13.5, "CHANnel:LIMit subsystem"](#), on page 206.

How to: ["To configure the limits for parameters"](#) on page 92

To configure the limits for parameters

E.g., select the U_{rms} parameter, set the maximum and minimum values and enable the limitation:

1. Press the [MEAS] key.
2. Press the "Limit" softkey.
3. In the limit softkey menu, press the "LIMIT" softkey to enable edit mode.

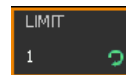

Figure 7-36: Limit softkey

4. Select, e.g., the 1st parameter you want to configure the limits for with the rotary knob, e.g. "1".
5. Press the "SOURCE" softkey.

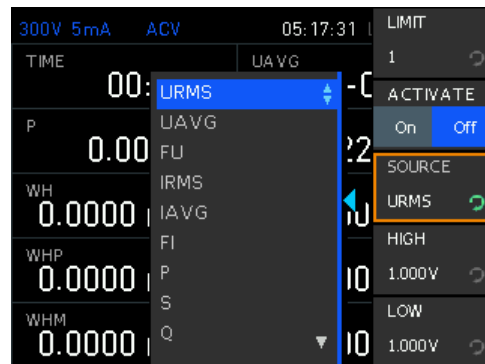

Figure 7-37: Limit source settings

6. Select the parameter by turning rotary knob, e.g. select "U_{rms}".
7. Confirm the selection by pressing the rotary knob.
8. Press the "HIGH" softkey.

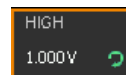

Figure 7-38: Upper limit softkey

9. Turn the rotary knob to set the upper limit value.
Alternatively, you can enter the value, using the keypad:
 - a) Press the [SHIFT] key.
 - b) Enter the value with the numeric keys of the keypad.
While entering the digits, the R&S NPA displays a softkey menu for selecting the unit, e.g., mV and V for voltage setting.
 - c) Press the corresponding unit softkey to confirm the setting.
10. Press the "LOW" softkey.

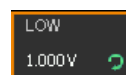

Figure 7-39: Lower limit softkey

11. Proceed the same way as described in [step 9](#) to set the lower limit value.
12. Repeat [step 5](#) to [step 9](#) to determine the limit values of all other parameters.
13. Select the corresponding limit parameters for display as described in ["To configure the numeric view"](#) on page 109.
14. Select "ACTIVATE" > "On".

Example of a measurement including limits display.

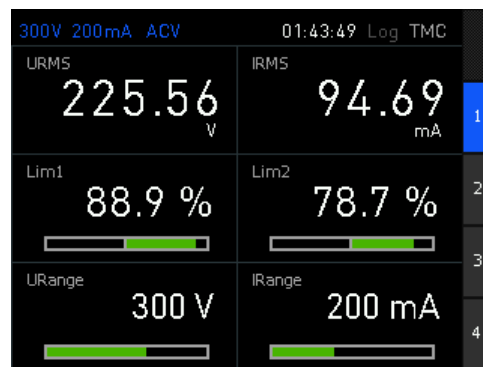

Figure 7-40: Limit measurement readings

The R&S NPA shows the limit check result of the selected parameter in %, and the limit ranging from -100% to 100% in a bar graph.

Settings

LIMIT.....	94
ACTIVATE.....	94
SOURCE.....	94
HIGH.....	94
LOW.....	94

LIMIT

Selects the position number to assign a parameter and its limits.

Available settings: "1...6"

Remote command:

n.a.

ACTIVATE

Turns on limitation for assigned parameters.

Remote command:

[CHANnel:LIMit<n>\[:STATe\]](#) on page 209

SOURCE

Selects the measurement parameter for limitation.

See [Table 7-1](#) for information on the available parameters.

Remote command:

[CHANnel:LIMit<n>:SOURce](#) on page 209

HIGH

Sets the upper limit (maximum value) for the parameter selected with [SOURCE](#).

Remote command:

[CHANnel:LIMit<n>:HIGH](#) on page 208

LOW

Sets the lower limit (minimum value) for the parameter selected with [SOURCE](#).

Remote command:

`CHANnel:LIMit<n>:LOW` on page 208

7.4 Standards

Instrument models R&S NPA501(-G) and R&S NPA701(-G) only

With standard measurements, the R&S NPA measures according to the measuring and calculation methods specified in the standards, and the required accuracy automatically.

Access:

1. Press the [MEAS] key on the front panel.
2. Press the "Standards" softkey.

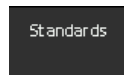

Figure 7-41: Measurement standard softkey



Figure 7-42: Measurement standard softkey menu

The R&S NPA701(-G) does not support remote control in standard measurement mode.

To configure a standard measurement

The verification wizard guides you through the steps to be taken for configuring a standard measurement.

- ▶ **NOTICE!** Risk of measurement deviations. The integrator function can falsify the compliance test.

To achieve correct measurement results, make sure that you have turned off the integrator function.

How to: [Chapter 7.5, "Measuring power consumption with the R&S NPA701"](#), on page 98

Settings

Standards.....	96
REGION.....	96
VOLTAGE.....	96
FREQUENCY.....	96
POWER.....	97
CLASS.....	97
CREST FACT.....	97
RANGE.....	97
PATTERN.....	97
CYCLE.....	97

Standards

Selects the measurement standard.

"EN 50564"	Standard for measuring the power consumption of electronic devices in standby mode.
"IEC 62301"	Standard for measuring the power consumption in extended standby mode.
"IEC 61000-3-2"	Standard for measuring the harmonic current for EMC and CE approval of electronic devices.

Remote command:

n.a.

REGION

Selects the region you are testing for.

You can select from a list of provided regions or set a user defined. Selecting one of the provided regions automatically sets the corresponding mains voltage and frequency.

"Europe", "China", "AU & NZ"	Select the regions Europe, China or Australia and New Zealand.
"USA & CA", "E. Japan", "W. Japan" (EN 50564 and IEC 62301 only)	Selects the regions United States of America and Canada, east Japan or west Japan.
"Customize"	User-defined region setting.

Remote command:

n.a.

VOLTAGE

Sets nominal mains voltage.

Remote command:

n.a.

FREQUENCY

Sets regional mains frequency.

Remote command:
n.a.

POWER

Sets the power consumption of the DUT. The R&S NPA uses this value to calculate the limits.

Applies to harmonic current measurements according to [IEC 6100-3-2 Standard](#).

Remote command:
n.a.

CLASS

Selects electromagnetic compatibility class of the DUT.

Applies to harmonic current measurements according to [IEC 6100-3-2 Standard](#).

Remote command:
n.a.

CREST FACT

Selects the crest factor for the current measurement.

Available settings: "1", "3", "6"

Remote command:
n.a.

RANGE

Selects the current range. The available range settings depend on the selected [CREST FACT](#), see [Table 6-2](#).

Remote command:
n.a.

PATTERN

Selects the consumption pattern.

"Static"	Constant current consumption.
"Variable"	Variable or irregular current consumption.
"Cyclic"	Repeating current consumption in time intervals.

Remote command:
n.a.

CYCLE

Sets the duration of the consumption pattern for [PATTERN > Cyclic](#).

Remote command:
n.a.

7.5 Measuring power consumption with the R&S NPA701

This measurement example requires an instrument of model R&S NPA701(-G) Compliance Tester to meet the requirements of the standards.

The measurement method refers to a standardized power measurement according to IEC62301 and EN50564. It enables you to analyze the standby power consumption of a DUT. The R&S NPA executes the measurement according to the measuring and calculation methods specified in the standards, and the required accuracy automatically.

To configure a standardized power measurement

The verification wizard guides you through the steps to be taken for configuring a standard measurement.

1. **NOTICE!** Risk of measurement deviations. The integrator function can falsify the compliance test.
To achieve correct measurement results, make sure that you have turned off the integrator function.
2. Press the [MEAS] key on the front panel.
3. In the measurement menu, press the "Standards" softkey.
4. Select the standard, e.g. "IEC 62301".
5. Select the "REGION" softkey to set the mains voltage of your country.

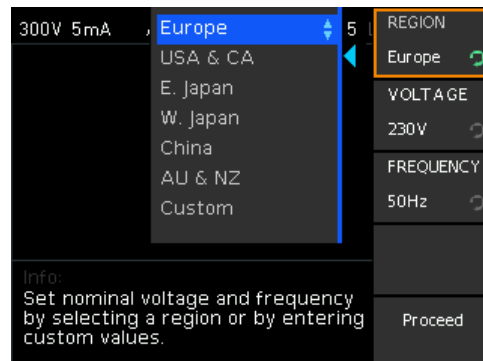

Figure 7-43: Standard measurement region selection

6. Select the region by turning the rotary knob, e.g. select "Europe".
The R&S NPA provides the country-specific mains values, but you can set the values also manually.
7. Press the rotary knob to confirm the selection.
The R&S NPA displays the nominal voltage and frequency parameters of the selected region. If necessary, select the corresponding parameter softkey to adjust a parameter individually.
8. Select "Proceed" to continue.
The R&S NPA displays the menu for setting the current parameters.

Measuring power consumption with the R&S NPA701

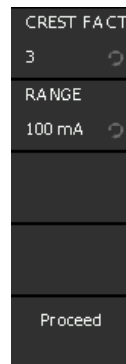

Figure 7-44: Standard measurement current parameters softkey menu

9. Select the crest factor
Proceed the same way to set the crest factor and the expected RMS current range. This specific measurement requires the maximum values.

a) Select the crest factor.

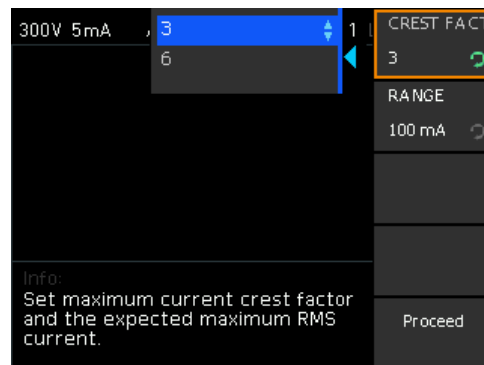
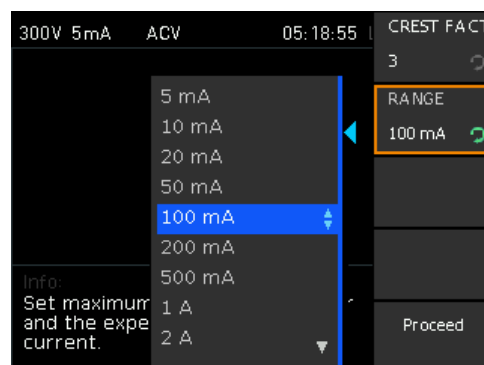

Figure 7-45: Standard measurement crest factor selection

b) Select the current range.



10. When completed, continue with "Proceed".

If known, you can select the type of current consumption in the next steps.

Note: A correctly selected consumption type speeds up the measurement. If the setting does not match, the R&S NPA recognizes the deviating behavior, but still measures correctly.

11. If applicable, set the consumption pattern, e.g. "PATTERN" > "Cyclic".

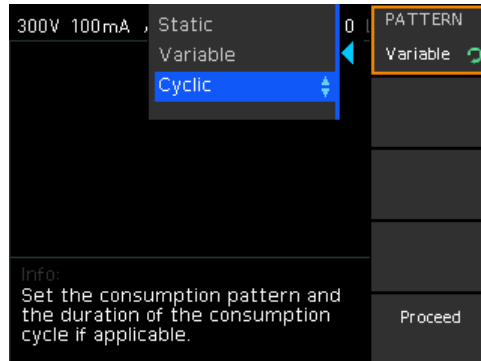

12. Select the "CYCLE" softkey to set the time interval of the cycle.
The "Set Duration" dialog with a time entry field (defined in <hour>:<minute>:<second>) opens.

The step shows how to set the parameters with the keypad:

- Press the [**◀**] arrow key to enable, e.g. the <minute> entry field.
- Press the [SHIFT] key.
- Enter the value with the numeric keys of the keypad.
- Confirm with [ENTER].
- Repeat the steps for completing the duration entry.

As an alternative, you can use the navigation controls to select the entry field, set the values and confirm your setting.

13. Select "Proceed" to continue.

The configuration is completed. The wizard displays the connection to the R&S NPA-Zx test adapter graphically.

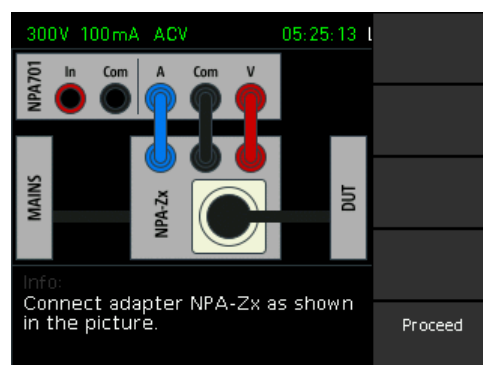

Figure 7-46: Standard measurement cabling

14. Check the test setup to make sure that the connections are correct.
[Chapter 3.1.10, "Connecting a device under test \(DUT\)"](#), on page 26 describes, how to connect the R&S NPA-Zx test adapter and the DUT in detail.
15. Continue with "Proceed".

The R&S NPA displays the configuration.

Measuring power consumption with the R&S NPA701

300V 100mA ACV		05:19:23	
	Value	Min	Max
URMS	226.21 V	-----	-----
FPLL	49.972 Hz	-----	-----
UTHD	1.58 %	-----	-----
UCF	1.407	-----	-----
P	0.014 W	-----	-----
PAvg	-----		
PF	1.000	PDev	-----
Info: Elapsed: 00:00:00 (01:00:00)			
Ready for measurement (out-of-spec values present)			
Activate DUT, then press [Start] to begin.			
Start			

Figure 7-47: Standard measurement configuration completed

- To start the measurement, proceed as described in ["To start the measurement"](#) on page 101.

When you have completed the configuration and checked the test setup, you can start the measurement, see ["To start the measurement"](#) on page 101.

To start the measurement

- Select the "Start" softkey.

The R&S NPA constantly monitors and records all parameters automatically. During the measurement, the status display shows all values and their range of variation.

- Wait until the measurement is completed.

300V 100mA ACV		05:19:32	
	Value	Min	Max
URMS	226.21 V	225.99	226.21
FPLL	49.979 Hz	49.971	49.981
UTHD	1.59 %	1.57	1.61
UCF	1.407	1.406	1.409
P	0.018 W	0.005	0.031
PAvg	0.016 W		
PF	1.000	PDev	-----
Info: Elapsed: 00:00:05 (01:00:00)			
Measurement in progress.			
Abort			

Figure 7-48: Standard measurement running

The R&S NPA displays the readings during the measurement.

300V 100mA ACV		05:20:01		Restart
	Value	Min	Max	
URMS	225.88 V	225.67	226.32	
FPLL	49.983 Hz	49.970	49.983	
UTHD	1.59 %	1.56	1.64	
UCF	1.406	1.406	1.410	
P	1.969 W	0.004	6.250	
PAvg	1.295 W			
PF	0.469	PDev	-----	Save HTML
Info: Elapsed: 00:00:23 (01:00:00)				Finish
Save the results on front USB by selecting [Save HTML] from the menu. The report can later be completed on a computer.				

Figure 7-49: Standard measurement finished

When completed, the display shows the measured values and value ranges, and confirms that the measurement was successful. If deviations occur, the message "Measurement not successful" confirms that there have been deviations. The R&S NPA highlights the corresponding values in different color.

To repeat or complete the measurement

You can terminate a measurement, or continue a stopped one.

1. To repeat the measurement, press the "Restart" softkey.
2. To terminate the measurement and change the measurement mode:
 - a) Press the [VIEW] key.
 - b) Select, e.g. the "Numeric" softkey, to close the previous measurement mode.

To save and evaluate measurement results

You can save the test report to an external USB memory device, e.g. for analyzing and evaluating the measurement.

The USB connector is on the front panel.

To save the test report:

1. Plug in a USB memory stick.
2. Press the "Proceed" softkey.
3. Select "Save HTML".

Measuring power consumption with the R&S NPA701

300V 100mA ACV	05:20:58	Restart
	Value Min Max	
URMS	226.10 V 225.99 226.32	
FPLL	49.970 Hz 49.967 49.974	
Save HTML Report		
Report saved to /USB_FRONT/ID000001.html		
Press [MENU OFF] to close this box		
		Save HTML
Info: Elapsed: 00:00:09 (01:00:00)		
Save the results on front USB by selecting [Save HTML] from the menu. The report can later be completed on a computer.		
		Finish

The R&S NPA creates a generic file name and saves the test report on the memory device with the extension *.html.

4. Press the "FINISH" softkey to finalize the measurement.

To view and customize the report of the compliance test

To view the test report, you can use any web browser that supports Java.

1. Open the *.html in the web browser.

Measuring power consumption with the R&S NPA701

Print Edit

ID: 000001 Page 1 of 2

Test Report

ID: 000001
Pre-compliance IEC 62301:2011

Customer	Test Lab
Device Under Test	Instrument of Measure
Consumption Pattern: Cyclic Cycle: 1 s	Manufacturer: ROHDE & SCHWARZ Device Type: Compliance Tester Model: NPA701 Serial Number: 000000000 Firmware Version: 00.007 Calibration Date: 2023-11-11 Voltage Range: 300 V Current Range: 0.100 A Current CF Range: 6
Test Summary	Test Conditions
Avg. Mains Voltage: 227.59 V Avg. Mains Freq.: 50.01 Hz Test Method: Sampling Method Avg. Power: 13.9322 W Result: PASSED (SUCCESSFUL)	Date: 2023-12-07 Time: 04:41:52 Duration: 613 s Mains Region: Europe Mains Voltage: 230 V Mains Frequency: 50.0 Hz Temperature: Humidity:
Notes	Test Officer
	Full Name: Signature: _____

ID: 000001 Page 2 of 2

	Detailed Results					
	Average	Min	Limit Min	Max	Limit Max	Result
Mains Voltage RMS:	227.59 V	226.54 V	227.70 V	228.28 V	232.30 V	FAIL
Mains Frequency:	50.01 Hz	49.98 Hz	49.50 Hz	50.03 Hz	50.50 Hz	PASS
Mains Voltage CF:	1.408	1.406	1.340	1.412	1.490	PASS
Mains Voltage THD:	1.46 %	1.38 %	N/A	1.52 %	2.00 %	PASS
Real Power:	13.932 W	13.788 W	N/A	14.042 W	N/A	N/A
Apparent Power:	21.763 W	21.391 W	N/A	21.996 W	N/A	N/A
Power Factor:	0.638	N/A	N/A	N/A	N/A	N/A

Figure 7-50: Compliance test report

When opened, you can edit specific entry fields of the report manually.

2. Select "EDIT" to enable edit mode.

Customer	Test Lab
Manufacturer	Rohde & Schwarz
Device Under Test	Instrument of Measure
DUT	Manufacturer: ROHDE & SCHWARZ

Figure 7-51: Customized entry fields

In edit mode, the test report highlights the editable entry fields.

Measuring power consumption with the R&S NPA701

3. Enter, e.g. the customer name, laboratory, type of the device under test, or information in the notes panel at the end of the page.
4. Select "Edit" to exit the edit mode.

The R&S NPA saves the modifications in the *.html file automatically.

To fill in customer-specific information automatically



As a specific feature, you have the option of filling in the fields "Customer", "Device Under Test" and the "Test Lab" automatically.

Prerequisite is that you create text files with the predefined file names `Customer.txt`, `Lab.txt` and `Dut.txt` before you start the standard measurement. You can add any labeling you want in these text files.

1. Open a standard text file application to create text files for the fields you want to fill in automatically.
 - a) Enter, e.g. the *Customer* designation.
 - b) Save the file with the file name `Customer.txt`.

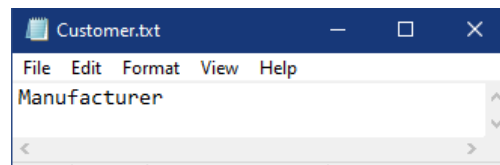

Figure 7-52: Test report example customized content

- c) Proceed the same way to create the `Dut.txt` and `Lab.txt` files accordingly.
2. Save the files on the USB stick.
3. Plug in the USB stick at the [front panel](#).

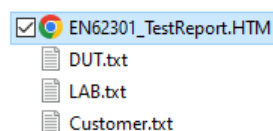

Figure 7-53: Test report example file on USB stick

4. Configure and start the standardized power measurement, as described under:
 - ["To configure a standardized power measurement"](#) on page 98
 - ["To start the measurement"](#) on page 101
5. When finished, save the test report, see ["To save and evaluate measurement results"](#) on page 102

The R&S NPA701(-G) assigns the texts you entered into the test report automatically, see also [Figure 7-51](#).

6. View the html file in a web browser.

The instrument then provides the customized entries in all following test reports.

8 Display modes

The instruments of the R&S NPA power analyzers indicate the measurement results in numeric mode by default. In addition, the R&S NPA501(-G) and R&S NPA701(-G) instruments provide several graphical display modes. Each display mode covers specific display parameters you can configure according to your application.

The display modes are based on the continuously measured values. Using these values, the instrument calculates and derives the non-measurable parameters for the graphical and tabular displays.

Access:

1. Press the [VIEW] key on the front panel.



Figure 8-1: View softkey menu

In the view menu, you can select the display mode.

Note: The available display modes depend on the instrument model, see [Overview of supported display modes](#).

For R&S NPA101 instruments, pressing the [VIEW] key switches between the four pages (toggle function).

2. Select a view in the softkey menu.

If available, the softkey leads you to the corresponding setting parameters for configuring the measurement result display.

Remote command:

[VIEW](#) on page 241

Table 8-1: Overview of supported display modes

Instrument model	Numeric	Harmonics	Waveform	Trendchart	Inrush
R&S NPA101	x	-	-	-	-
R&S NPA501(-G)	x	x	x	x	x
R&S NPA701(-G)	x	x	x	x	x

To leave the display mode

The  softkey does not close the view. To return to default (numeric) view:

1. Press the [VIEW] key on the front.
2. Select display mode "NUMERIC".

The remote commands required to define these settings are described in [Chapter 13.15, "VIEW subsystem"](#), on page 236.

• Numeric view	108
• Harmonics view	110
• Waveform view	114
• Trendchart view	116
• Inrush view	119
• Evaluating inrush data	125

8.1 Numeric view

The R&S NPA indicates the measurement results numerically.

The numeric view consists of four pages that indicate either 6 or 10 measurement parameters. For each page, you can customize the measurement assignment separately.

Access:

1. Press the [VIEW] key on the front panel.
2. Select the "Numeric" softkey.

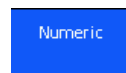

Figure 8-2: Numeric view softkey

The R&S NPA displays the measurement results of the selected parameters.

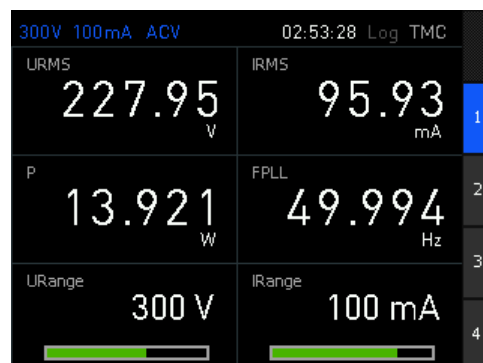

Figure 8-3: Numeric view display with 6 measurement parameters

To configure the numeric view

In a numeric page, you can toggle between six and 10 measurement parameters:

1. Press the [VIEW] key.
2. Press the "Numeric" softkey.

The numeric display shows the readings of six measurement parameters by default.

3. Press the "1" softkey to display more parameters.

The screen display toggles to the window indicating 10 parameter fields, listed in [Ten parameters displayed in numeric view \(default\)](#).

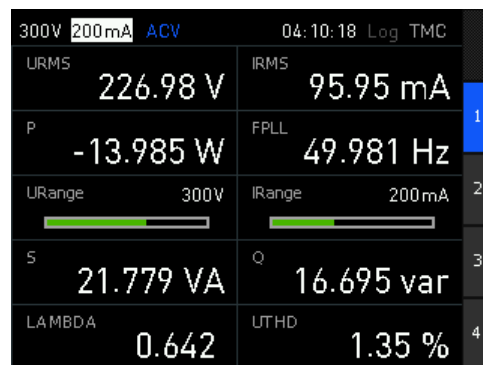

Figure 8-4: Numeric view display with 10 measurement parameters

Table 8-2: Ten parameters displayed in numeric view (default)

Parameter	Description (unit)	Parameter	Description (unit)
"URMS"	True RMS voltage (V)	"IRMS"	True RMS current (mA)
"P"	Active power (mW)	"FPLL"	PLL source frequency (Hz)
"URange"	Voltage range bar graph (V)	"IRange"	Current range bar graph (mA)
"S"	Apparent power (W)	"Q"	Reactive power (VA)
"LAMBDA"	Power factor λ	"UTHD"	Total harmonic distortion U (%)

To select parameters different from default display

The R&S NPA always measures all parameters, regardless of the parameters displayed on the screen. You can therefore select and display other parameters individually, by replacing the parameter in one of the displayed fields.

1. In numeric mode display, press the [rotary knob].
The first parameter field changes into edit mode, indicated by the blue background.
2. Select the field for indicating another parameter using the [rotary knob] or the [arrow] keys.
3. Press the [rotary knob].
A menu list with all measurement parameters appears.

4. Select the parameter you want to view.
5. Press the [rotary knob] to confirm the selection.
6. Repeat the steps until you have assigned the specific parameters on the screen display.



The R&S NPA saves the customized settings in its non-volatile memory and retrieves these settings at restart. In addition, you can save instrument settings for later reuse. See [Chapter 10, "File and data management"](#), on page 139.

The remote commands required to define the numeric view settings are described in [Chapter 13.15, "VIEW subsystem"](#), on page 236.

How to: ["To configure the numeric view"](#) on page 109

Settings

[1, 2, 3, 4](#).....110

1, 2, 3, 4

Selects the measurement page.

Using the rotary knob, you can select a cell within the display and assign the parameter for display.

Remote command:

[VIEW:NUMeric\[:SHOW\]](#) on page 244

[VIEW:NUMeric:PAGE<n>:CELL<m>:FUNction](#) on page 243

[VIEW:NUMeric:PAGE<n>:SIZE](#) on page 243

8.2 Harmonics view

Displays the magnitudes of the harmonics as a bar graph or in a table.

In the harmonics view, the R&S NPA calculates the RMS value and phase angle of the harmonics using the [FFT](#) (Fast Fourier Transformation) method. It considers up to 50 harmonics (up to a maximum of 100 kHz), and displays their voltage level and current level in a bar graph or in a table. This view represents the voltage and current values of the harmonics in percent or as absolute values.

The R&S NPA calculates the FTT continuously. Therefore, changes to the settings during measurement and calculation only affect the display.

Access:

1. Press the [VIEW] key on the front panel.
2. Select the "Harmonics" softkey.

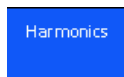

Figure 8-5: Harmonics view softkey

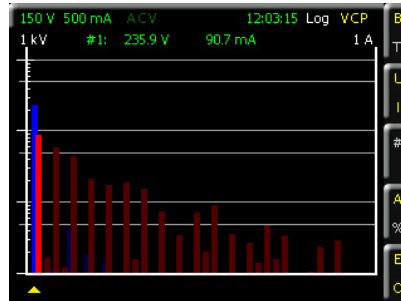

Figure 8-6: Harmonics view logarithmic display

The R&S NPA shows the voltage levels as blue bars in the diagram, and the current levels in red. The yellow triangle (cursor) at the bottom of the diagram provides navigation to select specific harmonics for evaluation, see ["To select a specific harmonic"](#) on page 112. The logarithmic display of the harmonics enables you to detect even the smallest signal details.

The remote commands required to define the harmonics view settings are described in [Chapter 13.15, "VIEW subsystem"](#), on page 236.

How to: [To configure the harmonics view](#)

To configure the harmonics view

E.g., configure the current and voltage magnitudes of all harmonics, displayed as a bar graph:

1. Press the [VIEW] key.
2. Press the "Harmonics" softkey.

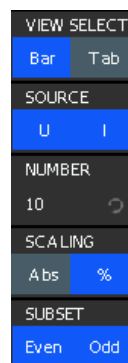



Figure 8-7: Harmonics view softkey menu

3. In the harmonics softkey menu, select "Bar" using the "VIEW SELECT" softkey.

4. Press the "SOURCE" softkey repeatedly until you have selected both, "U" and "I" (toggle function).
5. Press the "NUMBER" softkey.
6. Set the number of harmonics included in FTT calculation by turning rotary knob, e.g. set "10".
7. Select the scaling factor using the "SCALING" softkey, e.g. "%".
8. Select the harmonics included in FTT calculation. E.g., select the "SUBSET" softkey repeatedly until you have enabled both, "Even" and "Odd" (toggle function).

To select a specific harmonic

1. Configure the measurement, as described above.
2. Press the  key to fold down the harmonics softkey menu to a small menu bar. The display mode remains active, and the measurement window displays the results in full screen. The triangle at the bottom of the diagram appears, and the navigation controls light up.
3. Select a harmonic by turning the rotary knob, e.g. the fifth harmonic.

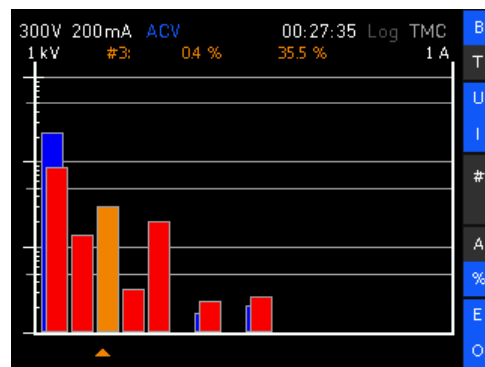

Figure 8-8: Harmonics selection with rotary control knob

The R&S NPA highlights the selected bar, and indicates the measurement values in the status bar.

To switch the display between bar graph and table

E.g., switch to tabular display:

1. In the harmonics softkey menu, select the "VIEW SELECT" softkey to enable "Tab".

Harmonics					VIEW SELECT	
Order	U[%]	Phi(U)[°]	I[%]	Phi(I)[°]	Bar	Tab
1	100.00	0.0	100.00	45.0		
2	0.03	177.4	16.54	-86.1		
3	0.37	-121.0	35.81	130.9		
4	0.03	-91.5	3.84	125.2		
5	0.46	-104.6	24.04	46.0		
6	0.01	-108.7	1.08	-45.2		
7	0.67	-74.7	2.54	-83.5		
8	0.03	123.3	0.43	25.5		
9	0.30	153.1	3.09	-133.8		
10	0.01	-108.1	0.87	146.4		

VIEW SELECT	
Bar	Tab
SOURCE	
U	I
NUMBER	
10	⌂
SCALING	
Abs	%
SUBSET	
Even	Odd

Figure 8-9: Harmonics view tabular display

The table shows the magnitude and phase of the selected parameters of the harmonics.

- To select a row for evaluating a specific harmonic, use the rotary knob.
- To view further values, configure the corresponding parameters for display in the softkey menu.

The remote commands required to define the harmonics view settings are described in [Chapter 13.15, "VIEW subsystem"](#), on page 236.

How to: ["To configure the harmonics view"](#) on page 111

Settings

VIEW SELECT.....	113
SOURCE.....	113
NUMBER.....	114
SCALING.....	114
SUBSET.....	114

VIEW SELECT

Selects the harmonics display.

"Bar"	Displays the amplitudes of the harmonics in a bar graph.
"Table"	Lists the magnitude and phase shifts of the measured voltage and current values in a table.

Remote command:

[VIEW:HARMonics:VIEW](#) on page 242

SOURCE

Selects the parameter to be visualized in a bar graph.

You can select either voltage, current or both parameters.

Note: This setting only applies to the bar graph. The table view always displays both, the voltage and the current values.

How to: see [To configure the harmonics view > step 4](#)

"U"	Shows voltage harmonics in the bar graph.
-----	---

"I" Shows current harmonics in the bar graph.

Remote command:

[VIEW:HARMonics:SOURce](#) on page 241

NUMBER

Sets the number of harmonics to be shown in the bar graph and the table view. You can select 5 to 50 harmonics for display.

Remote command:

[VIEW:HARMonics:NUMber](#) on page 241

SCALING

Selects the scaling for the display of harmonics relative to the fundamental wave.

Depending on the selected view, the display of voltage and current refers to the harmonics magnitudes in bar graph view, and to the numeric values in table view.

To select the view, see [VIEW SELECT](#).

"Abs" Displays absolute values of the measured current and voltage.

"%" Displays the current and voltage values in percent.

Remote command:

[VIEW:HARMonics:SCALing](#) on page 241

SUBSET

Selects the display of either the even, the odd or all harmonics in the selected range.

The setting applies to both, the bar graph and the table view.

Remote command:

[VIEW:HARMonics:SUBSET](#) on page 242

8.3 Waveform view

In waveform view, the R&S NPA displays the voltage, current and power data simultaneously as traces on the screen. Triggered by a hardware signal (FPLL), the R&S NPA automatically scales the diagram on the time axis to fit to a single signal cycle on the screen. You can select the waveform parameters, and statistical values for display.

Access:

1. Press the [VIEW] key on the front panel.
2. Press the "Waveform" softkey.

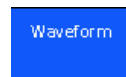

Figure 8-10: Waveform view softkey

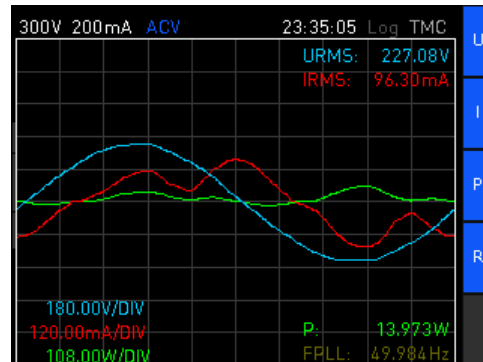

Figure 8-11: Waveform view display

The R&S NPA displays the voltage trace in blue, the current in red and the power in green. In the lower left corner, the graph shows the resolution of the vertical axis used for voltage, current and power. The upper right corner shows the voltage and measurement readings, the lower left corner shows the power readings and the frequency of the FPLL signal.

To configure the waveform view

In the waveform view, you can show or hide the traces individually and retrieve statistical values of the measurement results. Initially, the display of all parameters is enabled.

1. In the waveform softkey menu, press the  key to fold out the menu.

The expanded menu provides on and off switches for voltage, current and power display, and switches to show or hide statistics for the power and FPLL source frequency.

2. Press one of the softkeys "VOLTAGE", "CURRENT" or "POWER" to turn off the display.

The R&S NPA hides the trace, the numerical measurement reading and the vertical axis resolution of the selected parameter. To turn on the parameter display, press the softkey again (toggle function).

3. Press the "READOUTS" softkey to turn off and on the statistics display.

4. Press the  key to minimize the waveform softkey menu.

The R&S NPA shows the parameters abbreviated in a small softkey menu. The display mode remains active, and the measurement window displays the results in full screen.

The minimized softkey bar enables you to control the settings during the measurement conveniently.

The remote commands required to define the waveform view settings are described in [Chapter 13.15, "VIEW subsystem"](#), on page 236.

How to: ["To configure the waveform view"](#) on page 115

Settings

VOLTAGE.....	116
CURRENT.....	116
POWER.....	116
READOUTS.....	116

VOLTAGE

Displays the trace of the voltage in the waveform diagram.

Remote command:

[VIEW:WAVeform:VOLTagE](#) on page 245

CURRENT

Displays the trace of the current in the waveform diagram.

Remote command:

[VIEW:WAVeform:CURRent](#) on page 245

POWER

Displays the trace of the power in the waveform diagram.

Remote command:

[VIEW:WAVeform:POWer](#) on page 245

READOUTS

Enables the display of the statistical values U_{rms} , I_{rms} and P, the synchronizing frequency of the FPLL and the scaling of the x axis in the waveform diagram, see [Chapter 5.1, "Measurement parameters"](#), on page 54.

Remote command:

[VIEW:WAVeform:READOut](#) on page 245

8.4 Trendchart view

In the trendchart view, the R&S NPA displays the traces of two parameters over time. You can select the source parameters for trendchart display from the available parameters individually, see [Table 5-1](#).

The R&S NPA acquires the measurement values continuously. It clears the data of both traces automatically when you change the timebase or one of the data sources.

For information on the available parameters in trendchart mode, see [Table 5-1](#).

Access:

1. Press the [VIEW] key on the front panel.

2. Press the "Trendchart" softkey.

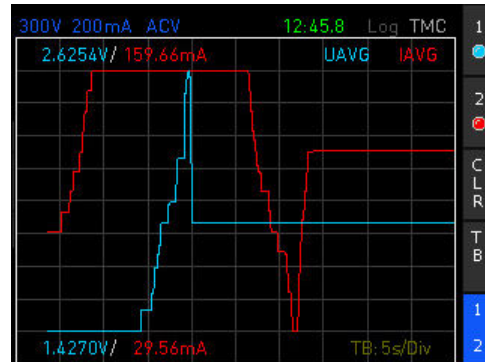



Figure 8-12: Trendchart view display

The R&S NPA displays the trace of the first parameter ("SCR 1") in blue and the second parameter ("SCR 2") in red. The graph shows the corresponding min/max values at the top and at the bottom, and indicates the resolution of the time axis in the lower right corner.

To configure the trendchart view

In the trendchart view, you can show the traces and readings of the selected parameters over time.

1. In the trendchart softkey menu, press the  key to fold out the menu.

The expanded menu provides two sources to select a parameter. You can restart the measurement, select the time resolution of the vertical axis, and enable one or both traces for display. Initially, the display of both parameters is enabled.

2. Select the "SRC1" softkey.

The menu list with the available parameters opens.

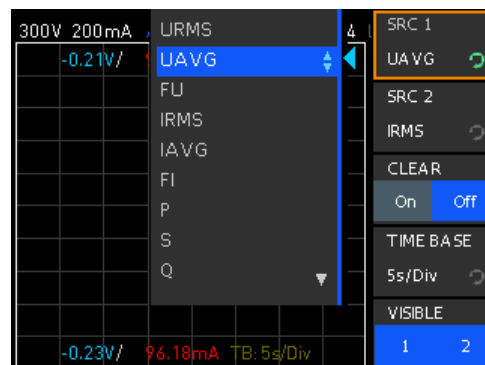

Figure 8-13: Trendchart view source selection

3. Select a parameter with the rotary knob or by repeatedly pressing the softkey.
4. Repeat [step 2](#) and [step 3](#) for the second source ("SCR2").
5. Press the "TIME BASE" softkey.

The menu list with the available time base settings opens.

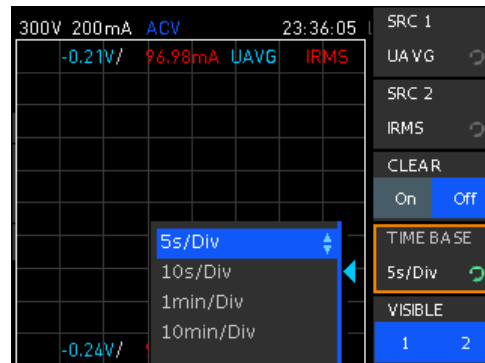



Figure 8-14: Trendchart view time base selection

6. Select the time resolution for the display with the rotary knob or with the softkey.
7. Press the "CLEAR" softkey to clear all acquired data from the screen.
8. Press the "VISIBLE" softkey repeatedly until you have selected both, "1" and "2" (toggle function).
9. Press the  key to minimize the trendchart softkey menu.

The R&S NPA shows the parameters abbreviated in a small softkey menu. The display mode remains active, and the measurement window displays the results in full screen.

The remote commands required to define the waveform view settings are described in [Chapter 13.15, "VIEW subsystem"](#), on page 236.

How to: ["To configure the trendchart view"](#) on page 117

Settings

SCR1, SCR2	118
CLEAR	118
TIME BASE	119
VISIBLE	119

SCR1, SCR2

Selects the measurement parameter.

Using the rotary knob, you can assign the parameter for display.

Remote command:

[VIEW:TRENDchart:SOURce<n>](#) on page 244

CLEAR

Deletes the trace data on the screen, and starts a new acquisition in the trendchart view.

Remote command:

[VIEW:TRENDchart:CLEar](#) on page 244

TIME BASE

Selects the time resolution for the trendchart view.

Using the rotary knob, you can select the time resolution per division.

Available settings are: "5 s/Div", "10 s/Div", "1 min/Div", "10 min/Div".

Remote command:

[VIEW:TRENDchart:TIMEbase](#) on page 244

VISIBLE

Selects the source for display in the trendchart diagram.

You can select either one or both sources.

How to: [To configure the trendchart view > step 8.](#)

Remote command:

[VIEW:TRENDchart:VISible<n>](#) on page 245

8.5 Inrush view

In inrush mode, the R&S NPA creates a high-samplerate record for a defined duration. An internal hardware buffer triggers the acquisition of the event and measures the current and voltage trends. Recording of data can be triggered manually, or on certain events in the voltage or current curve. This function allows you to capture rare events automatically, e.g., you can use this function to detect and measure inrush currents on loads.

You can acquire up to 8192 measured values each for current and voltage, save and export the values for evaluation. At the full sampling rate, the acquisition runs for 16 ms. You can vary the sampling rate to acquire signal sequences of up to a minute, as shown in [Table 8-3](#).

Table 8-3: Overview of sampling rates

Sampling rate	Acquisition time
500.00 kSamples/s	16 ms
250.00 kSamples/s	32 ms
125.00 kSamples/s	65 ms
62.50 kSamples/s	130 ms
31.25 kSamples/s	260 ms
15.63 kSamples/s	520 ms
7.81 kSamples/s	1 s
3.91 kSamples/s	2 s
1.95 kSamples/s	4 s
976.56 samples/s	8 s
488.28 samples/s	16 s

Sampling rate	Acquisition time
244.14 samples/s	33 s
122.07 samples/s	67 s

The trace in the inrush mode shows a single shot of a signal profile, triggered once. It does not update automatically.

Access:

1. Press the [VIEW] key on the front panel.
2. Press the "Inrush" softkey.

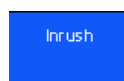

Figure 8-15: Inrush view softkey

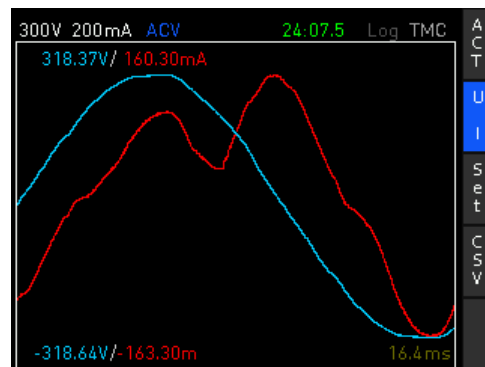

Figure 8-16: Inrush view display

The R&S NPA displays the trace of the voltage in blue and the current in red. The graph shows the corresponding min/max values at the top and at the bottom, and in the lower right corner, the selected acquisition time.

To configure the inrush view

In the inrush view, you can select the traces for voltage and current for display, set the acquisition time and the trigger mode:

1. In the inrush softkey menu, press the  key to fold out the menu.



Figure 8-17: Inrush view softkey menu

The expanded menu provides an on and off switch to activate the measurement. Softkeys allow you to show or hide the traces and to save the measurement results in a file. It leads you to a submenu to configure the acquisition time and trigger mode.

2. Press the "VISIBLE" softkey repeatedly until you have selected both, "U" and "I" (toggle function).
3. Select the "Settings" softkey.

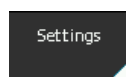

Figure 8-18: Inrush settings softkey

The inrush settings softkey menu with the provided parameters opens.



4. Select "ACQ TIME".

The menu list of provided acquisition time intervals opens.

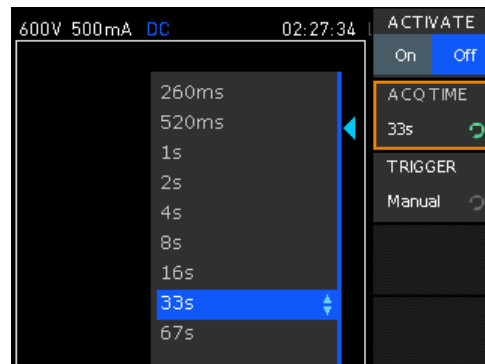

Figure 8-19: Inrush view acquisition time selection

5. Select the parameter with the rotary knob, e.g. "33s".
6. Select the "TRIGGER" softkey.

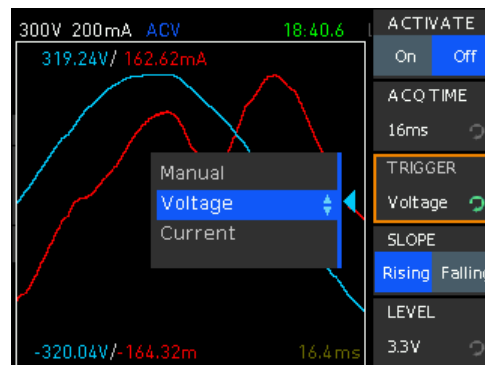

Figure 8-20: Inrush view trigger selection

7. Select the trigger mode, e.g. "Voltage" with the rotary knob.
8. Select "Level" to enable edit mode.

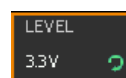



Figure 8-21: Inrush view level setting

9. Select the level value with the rotary knob.
10. Press the  key to fold down the inrush softkey menu to a small menu bar.
The display mode remains active, and the measurement window displays the results in full screen.
11. Press the "ACT" softkey to start the acquisition.
The R&S NPA starts the measurement.

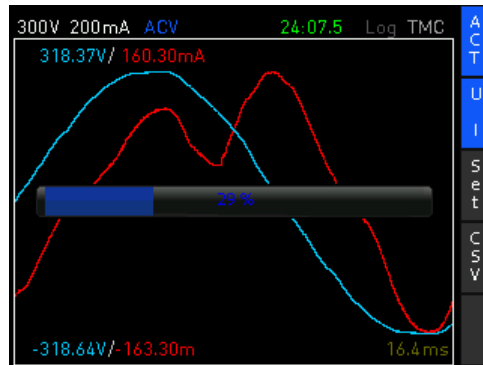

Figure 8-22: Inrush view acquisition running

For longer acquisition times, a bar indicates the progression of the recorded measurement.

12. Press the "CSV" to save recorded data acquisition.

The instrument creates a generic file name and saves the recorded acquisition data in *.csv format.

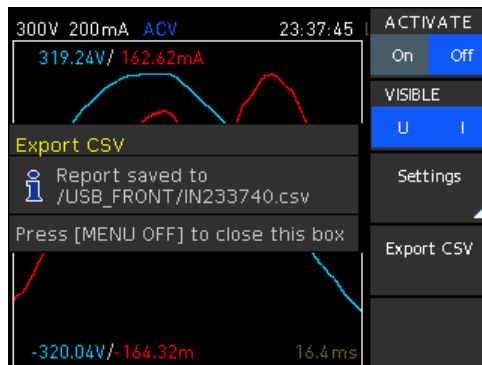

Figure 8-23: Inrush view data saved in csv

The remote commands required to define the waveform view settings are described in [Chapter 13.15, "VIEW subsystem"](#), on page 236.

How to: ["To configure the inrush view"](#) on page 120

Settings

ACTIVATE.....	124
VISIBLE.....	124
Settings.....	124
L ACTIVATE.....	124
L ACQ TIME.....	124
L TRIGGER.....	124
L SLOPE.....	125
L LEVEL.....	125
Export CSV.....	125

ACTIVATE

"On" starts data acquisition in inrush view.

"Off" aborts a running measurement and discards the recorded data.

Remote command:

[CHANnel\[:ACQuisition\]:INRush:ACTivate](#) on page 246

VISIBLE

Selects the source for display in the inrush diagram.

You can select either voltage, current or both parameters.

How to: see ["To configure the inrush view"](#) on page 120.

Remote command:

[VIEW:INRush:CURRent](#) on page 242

[VIEW:INRush:VOLTage](#) on page 243

Settings

Accesses the softkey menu for setting the trigger parameters of the inrush measurement.

ACTIVATE ← Settings

See [ACTIVATE](#). The R&S NPA provides this function also in the inrush settings sub-menu.

ACQ TIME ← Settings

Selects the time period for inrush measurement.

The time interval defines the duration of one inrush cycle.

Remote command:

[CHANnel\[:ACQuisition\]:INRush:TIME](#) on page 246

TRIGGER ← Settings

Selects the trigger source for the inrush measurement.

The measurement starts when the configured trigger condition is met and you have enabled the measurement with [ACTIVATE ON](#).

To configure the trigger condition for voltage or current, set [SLOPE](#) and [LEVEL](#).

When a measurement cycle is completed, the instrument sets [ACTIVATE OFF](#) automatically.

"Manual"	Initiates the inrush measurement manually by pressing the ACTIVATE softkey.
"Voltage"	The voltage trace triggers the measurement when the trigger condition is met.
"Current"	The current trace triggers the measurement when the trigger condition is met.

Remote command:

[CHANnel\[:ACQuisition\]:INRush:TRIGger](#) on page 247

SLOPE ← Settings

Selects the polarity of the active trigger source for the inrush measurement.

- "Rising" Triggers the measurement when the trigger signal passes the configured level on a rising slope.
- "Falling" Triggers the measurement when the trigger signal passes the configured level on a falling slope.

Remote command:

[CHANnel\[:ACQuisition\]:INRush:CURRent:SLOPe](#) on page 246

[CHANnel\[:ACQuisition\]:INRush:VOLTage:SLOPe](#) on page 247

LEVEL ← Settings

Sets the threshold value for the trigger signal, either [TRIGGER Voltage](#) or [TRIGGER Current](#).

The measurement is triggered when the signal passes this level. For setting the polarity, see [SLOPE](#).

Remote command:

[CHANnel\[:ACQuisition\]:INRush:CURRent:LEVel](#) on page 246

[CHANnel\[:ACQuisition\]:INRush:VOLTage:LEVel](#) on page 247

Export CSV

Saves the acquired data to a CSV file. Exporting the file is only possible when you have connected an external USB device to the instrument.

The R&S NPA assigns the filename automatically, composed of the trace designation and a time stamp, e.g. `IN163443.csv`.

To use the measurement results for evaluation, e.g. export the file to a PC application, see [Chapter 8.6, "Evaluating inrush data"](#), on page 125.

Remote command:

n.a.

8.6 Evaluating inrush data

For the analysis of the measurement results, you can use any spreadsheet program that supports `*.csv` file format and graphical representation also. For details on the file format, see [Chapter 11.3.7, "CSV"](#), on page 157. The following example shows the contents of a recorded inrush measurement file.

Example: Content and data format of an inrush measurement file

The content starts with meta data, which contains a unique identifier of the instrument, information on date, and measuring and duration, and the settings of the measurement. The following character string lists the measurement parameter names and the corresponding measured values, separated by customizable separators.

```
#Manufacturer;Rohde&Schwarz
#Device;NPA701-G
#Serial No.;036338276
```

```
#Version;01.403

#Acquisition time;67.108902
#Trigger;Manual
#Number of points;8192

Time [s];Voltage [V];Current [A]
0;0;9.35662e-06
0.008192;-0.0225271;1.87132e-06
0.016384;0;-1.87132e-06
0.024576;-0.0225271;-9.35662e-06
0.032768;0.0112636;-1.87132e-06
0.04096;0.00563179;3.74265e-06
0.049152;-0.0112636;-1.12279e-05
0.057344;-0.00563179;1.87132e-06
0.065536;-0.0112636;-1.87132e-06
0.073728;0.00563179;1.87132e-06
0.08192;-0.0168954;-7.4853e-06
0.090112;-0.00563179;-5.61397e-06
....
```

For description on how to load the file and how to represent the data using a PC application, see the example for evaluating logging data ["To import the log file to Microsoft®EXCEL"](#) on page 90.

9 External measurement modes

In addition to measurement setups using the measurement input connectors (A, V, COM, or the sensor IN, COM connectors) on the front panel, the R&S NPA501(-G) and R&S NPA701(-G) instruments provide analog and digital interfaces on the rear panel. The two analog and two digital input and output interfaces are intended for signals that you can assign, e.g., to define limit values, or perform pass/fail sorting.

Example: Validating the voltage of a measured DUT with an oscilloscope

R&S NPA measures the voltage of a connected 230 V DUT.

Settings on the R&S NPA:

- Crest factor: 3
- Measurement range: 300 V
- Analog output mode: "Voltage" (max. deflection of the analog output: +5 V referred to the measurement input)

Calculation:

$$U_{\text{range}} = 300 \text{ V} * 3 = 900 \text{ V (maximum measurement range).}$$

$$U_{\text{rms}} = (230 \text{ V} / 900 \text{ V}) * 5 \text{ V} = 1.278 \text{ V.}$$

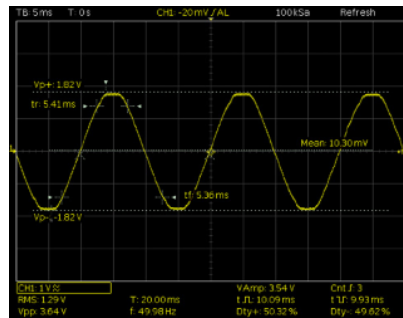

Figure 9-1: Example of the analog output signal displayed on an oscilloscope

The oscilloscope shows the sine wave with $U_{\text{rms}} = 1.278 \text{ V}$ and $U_{\text{pp}} = 3.6 \text{ V}$.

Access:

- ▶ Press the [EXT] key on the front panel.

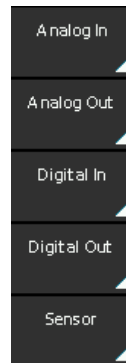

Figure 9-2: External input and output softkey menu

The softkey menu provides access to the parameters and settings for configuring the analog and digital input and output signals.

The remote commands required to define these settings are described in [Chapter 13.4, "CHANnel:EXTernal subsystem"](#), on page 197.

9.1 Analog input and output settings

With the analog input, you can measure an analog input signal and display the readings. The analog output signal enables you, to display the signal for evaluation on a connected external measurement instrument, e.g. an oscilloscope.

To configure an analog input signal measurement

This example assumes, that the measurement is set up and ready for operation. Before activating the measurement, select and assign the measurement parameters of interest for display, e.g. select the analog input value A_{IN} :

1. To select, e.g., the second measurement page, press the "2" softkey.
2. Press the rotary knob to activate the edit mode.
3. Select the field on the measurement page with the [rotary knob] or the arrow keys.
4. Press the rotary knob again to open the parameter list.
5. Select the parameter "AIN".
6. Confirm the selection with the rotary knob.
7. Repeat [step 3](#) to [step 6](#) until you have assigned all parameters for results display on the screen.
8. Press the [EXT] key.

9. Press the [Analog In] softkey.
10. Turn on the measurement with "ACTIVATE" > "On".

The R&S NPA displays the analog input signal.

To configure an analog output signal

This example assumes, that the measurement is set up and ready for operation. Before activating the measurement, select and assign the measurement parameters of interest for display, e.g. select the voltage, current power and limits:

1. To select, e.g., the third measurement page, press the "3" softkey.
2. Press the rotary knob to activate the edit mode.
3. Select the field on the measurement page with the [rotary knob].
4. Press the rotary knob again to open the parameter list.
5. Select the parameter "URMS" using the [rotary knob] or the arrow keys.
6. Confirm the selection with the rotary knob.
7. Repeat [step 3](#) to [step 6](#) to assign the parameters "IRMS", "P", "S" and "Lim1/2" for results display on the screen.
8. Press the [EXT] key.
9. Press the [Analog Out] softkey.
10. Turn on the measurement with "ACTIVATE" > "On".

The R&S NPA displays the settings of the analog output signal.

Settings

ACTIVATE.....	129
MODE.....	129
LIMIT NO.....	130

ACTIVATE

Turns on the measurement of an analog input or output signal.

Remote command:

`CHANnel[:EXTErn]:AINPut[:STATe]` on page 202

MODE

Selects the analog output mode.

- | | |
|-----------|--|
| "Voltage" | Selects voltage mode for the signal at the output. The voltage of the output signal corresponds to the voltage at the measurement input referred to ± 5 V. |
| "Current" | Selects current mode for the signal at the output. The current of the output signal corresponds to the current at the measurement input referred to ± 5 V. |

"Power"	Selects power mode for the signal at the output. The output power of the signal corresponds instantaneous power referred to ± 5 V.
"Limit"	Selects the limit function as output mode. The modulation amplitude of the output signal is given in percent referred to ± 5 V. To select the limit parameters, see Chapter 7.3, "Limit" , on page 91.

Remote command:

`CHANnel[:EXTErn]:AINPut[:STATe]` on page 202

`CHANnel[:EXTErn]:AOUTput[:STATe]` on page 203

LIMIT NO

Selects the position number to assign a parameter and its limits.

Available settings: "1...6"

Remote command:

n.a.

9.2 Digital input and output settings

With the digital input, you can measure a digital input signal and display the readings. The digital output signal allows you to assign a digital signal to the output, e.g. to provide information with logical true/false information on a parameter with defined limit values.

To configure a digital input signal measurement

This example assumes, that the measurement is set up and ready for operation. Before activating the measurement, select and assign the measurement parameters for display, e.g. select the analog input value D_{IN} :

1. To select, e.g., the first measurement page, press the "1" softkey.
2. Press the rotary knob to activate the edit mode.
3. Select the measurement field with the [rotary knob] or the arrow keys.
4. Press the rotary knob again to open the parameter list.
5. Select the parameter "DIN".
6. Confirm the selection with the rotary knob.
7. Repeat [step 3](#) to [step 6](#) until you have assigned all parameters for results display on the screen.
8. Press the [EXT] key.
9. Press the [Digital In] softkey.
10. Press the "MODE" softkey.
11. Select the mode, e.g., "State".

12. Activate inversion with "INVERT" > "On".
13. Turn on the measurement with "ACTIVATE" > "On".

The R&S NPA displays the readings of the digital input signal.

To configure a digital output signal

This instruction example assumes, that the measurement is set up and ready for operation. Before activating the measurement, select and assign the measurement parameters for display, e.g. select the voltage, current, frequency and limits:

1. To select the measurement page, press e.g., the "4" softkey.
2. Press the rotary knob to activate the edit mode.
3. Select the field on the measurement page with the [rotary knob].
4. Press the rotary knob again to open the parameter list.
5. Select the parameter "URMS" using the [rotary knob] or the arrow keys.
6. Confirm the selection with the rotary knob.
7. Repeat [step 3](#) to [step 6](#) to assign, e.g., the parameters "IRMS", "FU", "FPLL" and "Lim1/2" for results display on the screen.
8. Press the [EXT] key.
9. Press the "Digital Out" softkey.
10. Turn on the measurement with "ACTIVATE" > "On".

ACTIVATE.....	131
MODE (Digital In).....	131
INVERT (Digital In).....	132
MODE (Digital Out).....	132
LIMIT NO.....	132
INVERT (Digital Out).....	132

ACTIVATE

Turns on the measurement of a digital input or output signal.

Remote command:

`CHANnel [:EXTErn] :DINPut [:STATe]` on page 204

`CHANnel [:EXTErn] :DOUtput [:STATe]` on page 204

MODE (Digital In)

Selects the digital input mode.

"Frequency" Measures the frequency of the incoming digital signal.

"PWM" Measures the ratio of the high to low times of the signal.

"State" Measures the high and low levels of the signal.

Remote command:

`CHANnel [:EXTErn] :DINput:MODE` on page 203

INVERT (Digital In)

Turns the sign of the incoming digital signal.

Remote command:

[CHANnel\[:EXTern\]:DINPut:INVert](#) on page 203

MODE (Digital Out)

Selects the digital output mode.

"Limit" Selects the limit function as output mode.
A high signal level refers to logically true, correspondingly low level refers to logically false.
To select the limit parameters, see [Chapter 7.3, "Limit"](#), on page 91.

"FPLL" Provides the frequency of the selected source at the digital output.

Remote command:

[CHANnel\[:EXTern\]:DOUtput:MODE](#) on page 204

LIMIT NO

Selects the position number to assign a parameter and its limits.

Available settings: "1...6"

Remote command:

n.a.

INVERT (Digital Out)

Turns the sign of the provided digital signal.

Remote command:

[CHANnel\[:EXTern\]:DOUtput:INVert](#) on page 204

9.3 Sensor settings

Access:

1. Press the [EXT] key on the front panel.
2. In the external menu, select the "Sensor" softkey.

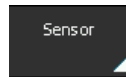

Figure 9-3: Sensor softkey

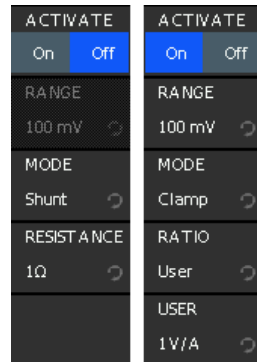

Figure 9-4: Sensor softkey menus for external shunt and external current clamp

The "Sensor" softkey menu contains all parameters required to configure the measurement using an external probe, e.g. the R&S HZC50 or R&S HZC51. Depending on the selected probe, the available parameters vary.

The remote commands required to define these settings are described in [Chapter 13.4, "CHANnel:EXternal subsystem"](#), on page 197.

Settings

ACTIVATE	133
RANGE	133
MODE	134
RESISTANCE	134
RATIO	134
USER	134

ACTIVATE

Starts the sensor measurement.

The function enables the sensor [IN] and [COM] connectors on the front panel. It automatically turns off an active automatic current measurement.

Remote command:

[CHANnel\[:EXtern\]:SENSor\[:STATe\]](#) on page 205

RANGE

Selects the maximum measurement range for the voltage measurement.

"100 mV" For measurements with shunts.

"1 V", "4 V" For measurements with current probes.

Remote command:

[CHANnel\[:EXtern\]:SENSor:RANGe](#) on page 206

MODE

Selects the type of the external probe.

"Shunt" For measurements with shunts.

"CLAMP" For measurements with clamp-on current probes.

Remote command:

`CHANnel[:EXTern]:SENSor:MODE` on page 205

RESISTANCE

Sets the resistance value for measurements with an external shunt in ohms.

To select the probe, set **MODE > Shunt**.

How to: see ["To configure a measurement with an external shunt"](#) on page 135.

Remote command:

`CHANnel[:EXTern]:SENSor:EXTShunt[:RESistance]` on page 205

RATIO

Selects the voltage to current ratio for measurements with current probes in mV/A.

To select the current probe type, set **MODE > Clamp**.

The ratio determines the amount of voltage the sensor transmits at 1 A applied current.

Based on this value, the R&S NPA calculates all parameters derived from the measured current and power values automatically.

"1 mV/A", "10 mV/A"

For measurements with the current probes R&S HZC50 or R&S HZC51.

"User" For measurements with current probes from other manufacturers.

How to: see ["To configure a measurement with an external clamp-on probe"](#) on page 136.

Remote command:

`CHANnel[:EXTern]:SENSor:CCLamp[:RATio]` on page 205

USER

Sets the voltage to current ratio for measurements with current probes in mV/A manually.

To select the current probe type, set **MODE > Clamp**.

To switch to a user-definable setting, select **RATIO > User**.

How to: see ["To configure a measurement with an external clamp-on probe"](#) on page 136.

Remote command:

`CHANnel[:EXTern]:SENSor:CCLamp[:RATio]` on page 205

9.4 Measuring with an external probe or shunt

The external measurements clamp-on probes or shunts require that you select the optimum measurement range, usually the maximum range referred to peak. I.e. the

appropriate range for measurements with shunts is 100 mV, and 1 V or 4 V with current clamp-on probes.

The examples assume that you have set up the measurement with an external probe, as described in [Chapter 4.4, "Connecting an external AC/DC shunt or clamp-on current probe"](#), on page 52.

To configure a measurement with an external shunt

For measurement setup, see [Chapter 4.4, "Connecting an external AC/DC shunt or clamp-on current probe"](#), on page 52.

1. Press the [EXT] key on the front panel.
2. In the external softkey menu, press the "Sensor" softkey.

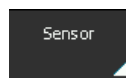

Figure 9-5: Sensor softkey

The sensor softkey menu opens.

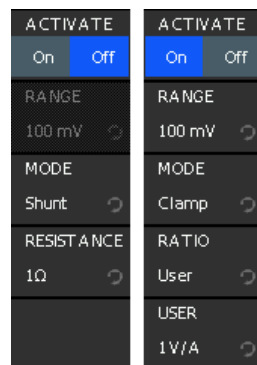

Figure 9-6: Sensor softkey menus for shunt of current clamp settings

3. Press the "Mode" softkey.
4. Select "Shunt".

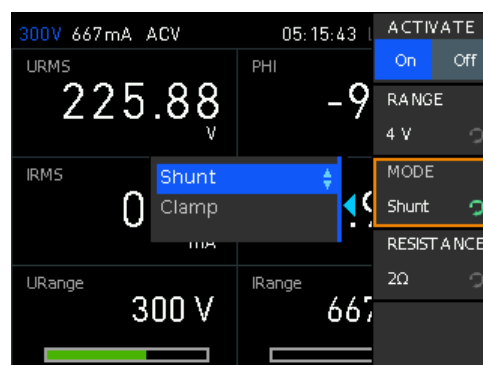

Figure 9-7: Sensor mode shunt selection

The R&S NPA adjust the sensor menu to the parameters required for the measurement with a shunt automatically. I.e. it provides "RESISTANCE" softkey for setting the resistance of the shunt.

5. Press the "RESISTANCE" softkey to enable edit mode.

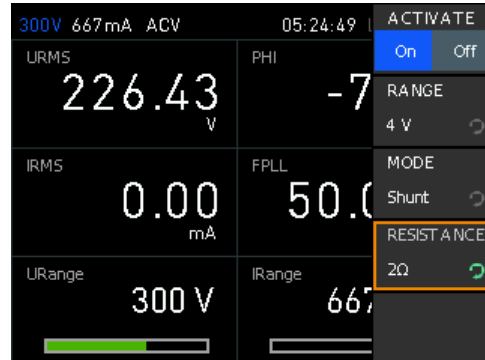

Figure 9-8: Sensor mode shunt resistance setting

6. To set the value, use the keypad:
 - a) Press the [SHIFT] key.
 - b) Enter the value using the keypad, e.g. set "2".
 - c) Select the unit with the softkey, e.g. "Ω".

The R&S NPA assigns the setting and returns to the sensor menu automatically.

Based on the shunt resistance, the instrument adjusts the measured current and power values and calculates all derived parameters.

To configure a measurement with an external clamp-on probe

For measurement setup, see [Chapter 4.4, "Connecting an external AC/DC shunt or clamp-on current probe"](#), on page 52.

1. Press the [EXT] key on the front panel.
2. Press the "Sensor" softkey.

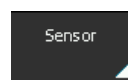

Figure 9-9: Sensor softkey

3. Select "Mode".
4. Select "Clamp".

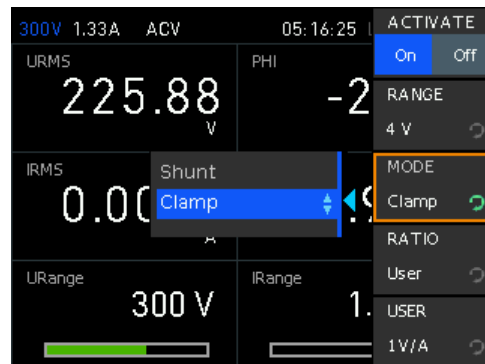

Figure 9-10: Sensor mode clamp resistance setting

The R&S NPA adjust the sensor menu to the parameters required for the measurement with a clamp-on probe. I.e. it provides the "RATIO" softkey for setting the conversion factor.

5. Press the "RATIO" softkey to enable edit mode.

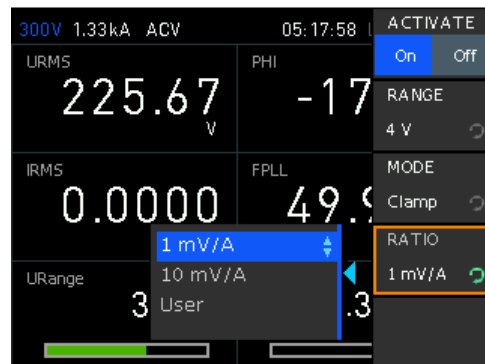

Figure 9-11: Sensor mode clamp ratio selection

6. Select the value, i.e. "1 mV/A".
7. To set a user-defined ratio value, select "User".

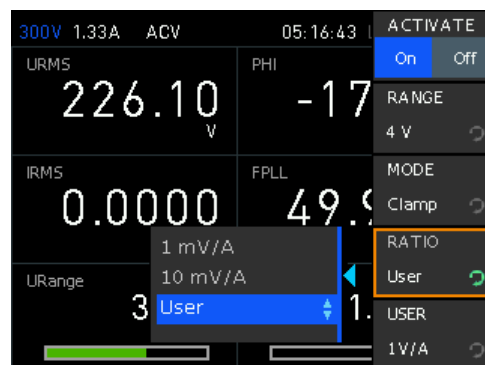

Figure 9-12: Sensor mode clamp ratio selection for user-defined settings

- a) Press the [SHIFT] key.

- b) Enter the value using the keypad, e.g. set "1".
- c) Confirm the setting with the "OK" softkey.

The R&S NPA assigns the setting and returns to the sensor menu.

Based on the shunt resistance, the instrument adjusts the measured current and voltage values and calculates all derived parameters.

To select the parameter display and start an external measurement

1. Select the measurement readings page indicating the voltage and current range, i.e. the parameters "URange" and "IRange".

How to: ["To select parameters different from default display"](#) on page 109.

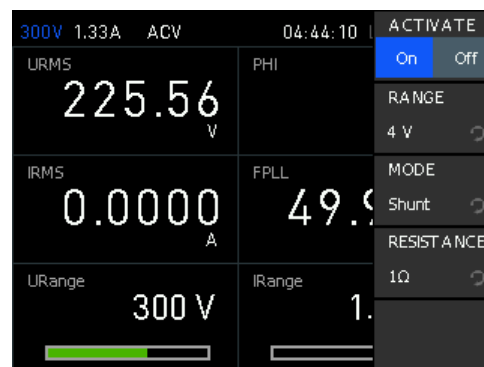

Figure 9-13: Maximum voltage range of a sensor measurement with an external shunt

2. Start the measurement with "ACTIVATE" > "On".

Note: When the sensor measurement is enabled, the R&S NPA turns off an active automatic current measurement ("AUTO").

The "ACTIVATE" softkey switches on the sensor inputs "IN" and "COM" on the instrument front panel (hardware switch).

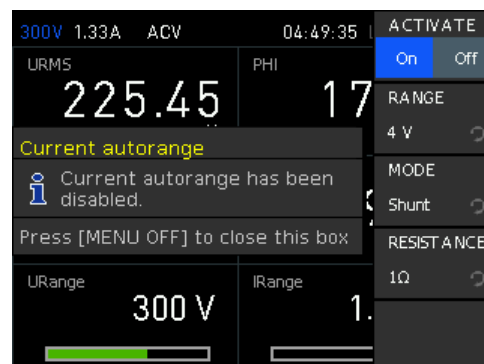

Figure 9-14: Sensor measurement disables automatic current measurement mode

10 File and data management

The R&S NPA enables you to save instrument configurations, settings and screenshots of the current screen. Depending on the type of data, you can use the internal memory, or save data to an external USB memory device.

Type of data files

Data files include measurement configurations and records, screenshots and instrument settings.

Depending on the content, user data is roughly categorized in the following data types:

- *Settings*: instrument settings of a measurement configuration saved for later reuse, see ["To save instrument settings"](#) on page 39.
- *Measurement readings*: recorded measurement results saved for evaluation, see [Chapter 7.2, "Data logging"](#), on page 80, and [Chapter 8.5, "Inrush view"](#), on page 119.
- *Screenshots*: screen captures of settings or measurement mode windows, see [Chapter 10.2, "Screenshot"](#), on page 142.

File memory location

The R&S NPA saves user files on the internal memory or, if connected, on a USB memory stick, but screenshots only on an external USB. With the "File Manager" functions, you can exchange files between the internal and an external memory, provided you have connected a USB memory stick.

The memory locations on the internal memory are predefined, on an external USB stick, you can create, define or delete directories as known from common file explorers.

10.1 Save/recall instrument states

With the "Save/Recall" functions you can save a certain instrument configuration in a file and reload it for later reuse.

Access:

- ▶ Press the [SAVE/RECALL] key on the front panel.

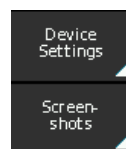

Figure 10-1: Save recall softkey menu

The save/recall softkey menu provides access to the system file for saving and restoring instrument settings.

To save instrument settings

- ▶ For information on how to save a current instrument configuration, see [Trying out the instrument](#) > "To save instrument settings" on page 39.

To recall instrument settings

To load a settings configuration from a file, proceed the same way:

1. Press the [SAVE/RECALL] key on the front panel.
2. Press the "LOAD" softkey to open the system file manager dialog.

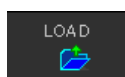

Figure 10-2: Load softkey

3. Select the memory location, e.g. "STORAGE" > "Front".
4. Select the file.
5. Upload the settings file with "Load".

The R&S NPA restores the instrument settings from the file.

To remove an instrument settings file

To remove a settings configuration file, proceed as follows:

1. Press the [SAVE/RECALL] key on the front panel.
2. Select the "Device Settings" softkey.



Figure 10-3: Device settings softkey

3. Select "LOAD" to open the file manager dialog.
4. Select the memory location, e.g. "STORAGE" > "Front".
5. Select the file with the rotary knob.
6. Delete the settings file with "Delete file".

The R&S NPA removes the instrument settings file from the memory. On the external USB memory, you can also change or delete directories.

To recall instrument default settings

You can reset all instrument settings to factory default values, without affecting your specific system settings.

1. Press the [SAVE/RECALL] key on the front panel.
2. Press the "Default settings" softkey.

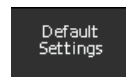

Figure 10-4: Default settings softkey

The R&S NPA resets current instrument settings to factory default.

Save.....	141
Storage.....	141
Filename.....	141
Comment.....	141
Load.....	141
Remove directory.....	141
Delete file.....	141
Default Settings.....	141

Save

Saves instrument settings.

Remote command:

*SAV <Storage> on page 187

Storage

Selects the memory location.

Filename

Assigns the filename to an instrument settings file.

Comment

Sets comment on the filename for device settings.

Load

Restores instrument settings.

Remote command:

*RCL <Storage> on page 187

Remove directory

Removes selected directory.

Delete file

Deletes selected file.

Default Settings

Resets device settings to factory default.

10.2 Screenshot

With the screenshot function, you can capture the image of the current screen and save it in a graphic file.

Aspects to screenshot files

- File storage location
Saving a screenshot file is only possible on an external USB stick.
- File format
Support formats are * .png (Portable Network Graphic) and * .bmp (Windows Bitmap).
- File name
You can assign an individual user-defined name, otherwise the R&S NPA assigns a unique, generic filename by default.
- Color
You can capture the display in the color of the screen, or converted to grayscale.

Access:

- ▶ Press and hold the [Save/Recall] key on the front panel.

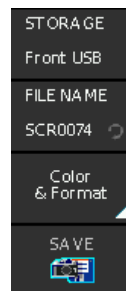

Figure 10-5: Screenshot softkey menu

To configure screenshots

1. Press and hold the [SAVE/RECALL] key on the front panel.

The R&S NPA opens the screenshot softkey menu.

Note: Saving a screenshot is available only if you have a USB stick connected.

2. Select the "Filename SCR...0001" softkey.

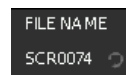

Figure 10-6: Filename softkey

An on-screen keyboard opens.

For screenshots, the R&S NPA assigns the default filename SCRxxxx. "xxxx" refers to an incremental index starting from "0001".

3. To assign a file name, you have the following options:

- a) To enter an individual file name using the keyboard, see ["Entering alphanumeric data"](#) on page 45.
 - b) To assign a generic file name, select the "Default" softkey.
The instrument generates the file name and closes the on-screen keyboard.
4. Select the "Color & Format" softkey.

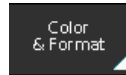

Figure 10-7: Color format softkey

5. Select the file format for the screenshot file.

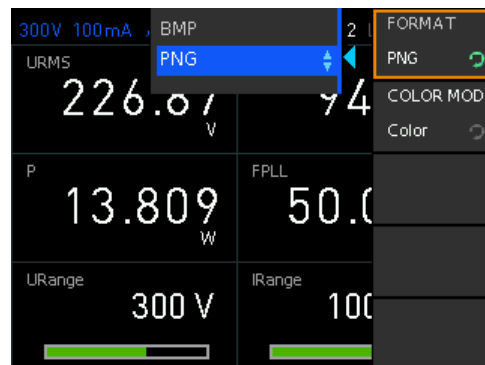

Figure 10-8: Screenshot select file format

6. Select the color mode for the screenshot file.

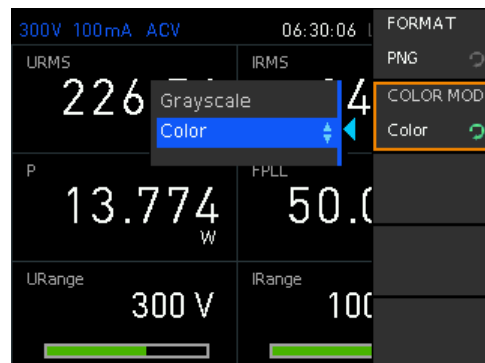

Figure 10-9: Screenshot select file format

7. Select "SAVE" to save the screenshot.

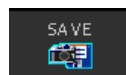

Figure 10-10: Save screenshot softkey

8. Press the  key to return leave the softkey menu.

To create a screenshot

- ▶ Press and hold the [SAVE/RECALL] key.

The instrument confirms the created screenshot.

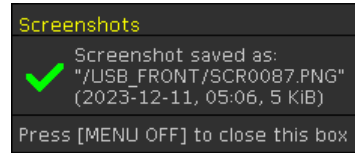

Figure 10-11: Screenshot saved

After a few seconds, the message closes automatically.

STORAGE.....	144
FILENAME.....	144
Color & Format.....	144
L FORMAT.....	144
L COLOR MODE.....	144
SAVE.....	144

STORAGE

USB storage only.

FILENAME

Sets filename for screenshot.

Color & Format

Sets color and format for screenshot.

FORMAT ← Color & Format

Sets format for screenshot.

"BMP" Screenshot is saved as bitmap image file format.

"PNG" Screenshot is saved as portable network graphic format.

Remote command:

[HCOPY: FORMat](#) on page 218

COLOR MODE ← Color & Format

Sets color mode for screenshot.

"Grayscale" Screenshot is saved in black and white color mode.

"Color" Screenshot is saved in the colors of the R&S NPA screen.

SAVE

Saves current display in screenshot.

Function is available only if USB stick is connected.

Remote command:

[HCOpy:DATA?](#) on page 217

[HCOpy:SIZE:X?](#) on page 218

[HCOpy:SIZE:Y?](#) on page 218

11 General instrument settings

The general instrument settings include basic instrument settings and utility services, regardless of the selected operating mode and measurement.

Access:

1. Press the [SETUP] key on the front panel.

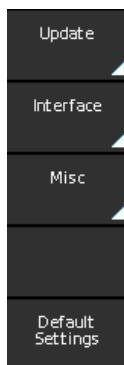

Figure 11-1: Setup softkey menu

2. In the setup softkey menu, select a softkey to access the corresponding submenu.

• Update (firmware)	146
• Interface	149
• Miscellaneous	149
• Power up	160
• Default	161

11.1 Update (firmware)

The update functionality provides information on the currently installed firmware version, including the instrument help. Using the USB interface on the front panel, you can update the firmware.

We recommend that you use the latest firmware version available on the product page at www.rohde-schwarz.com/firmware/npa.

Required equipment

- Software:
Firmware update file `RS_NPAxxx_Firmware_<version>.zip`
- Hardware:
USB memory stick with at least 10 MB free space to save the update file.
The memory stick does not need to be bootable and previous data on the stick is not affected. During the update procedure, the stick is not modified by the instrument.

Access:

1. Press the SETUP key on the front panel.
2. In the setup softkey menu, select the "Update" softkey.

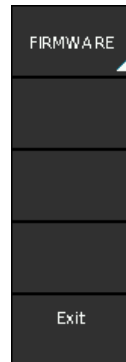

Figure 11-2: Firmware update softkey menu

The "Device Firmware" dialog shows the currently installed firmware and enables you to perform a firmware update. Messages inform you about the progress of the update.

To update the instrument firmware

1. Download the latest version of the R&S NPA firmware from the Rohde & Schwarz website.
2. Extract the compressed firmware *.zip file.
3. Copy the extracted file NPAX01.HFU to the root directory of the USB memory stick.

Note: Consider not to change the file name of the firmware, as the firmware update only works when the file name is NPAX01.HFU. If you have several update files on the stick in parallel, copying the file does not replace it, but rather rename the file automatically.

4. Press the [SETUP] key.
5. Select the "Update" softkey.

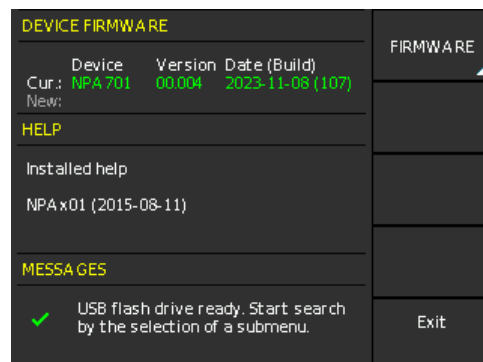

Figure 11-3: Device firmware dialog

If not yet connected, the instrument prompts you to attach a USB flash drive with the firmware file.

6. Select the "Firmware" softkey.
7. Connect the USB memory stick to the USB interface on the front panel.

The R&S NPA scans the USB memory stick for firmware file types. If a NPAx01.HFU file is on the USB stick, the R&S NPA automatically uploads the file and indicates both, the currently installed and the newly loaded firmware versions, including the build date. A message confirms the upload and that the checksum of an internal check is correct.

DEVICE FIRMWARE			Execute
Device	Version	Date (Build)	
Cur.: NPA 701	00.004	2023-11-08 (107)	
New: NPAx01	00.007	2023-11-23 (136)	
HELP			
Installed help			
NPAx01 (2015-08-11)			
MESSA GES			
✓	Loading file finished: NPAx01.HFU The checksum is correct.		Cancel

Figure 11-4: Firmware uploaded

Note: If the new version is more recent than the installed version, the version information is displayed in green, for the same or older versions in red.

DEVICE FIRMWARE		
Device	Version	Date (Build)
Cur.: NPA 701	00.004	2023-11-08 (107)
New: NPAx01	00.004	2023-11-08 (107)

Figure 11-5: Uploaded firmware is the same or older than the installed version

If the upload failed, see [Chapter 14.2, "Problems during firmware update"](#), on page 248.

8. **NOTICE!** Risk of potential damage to the firmware. Disconnecting the power supply while an update is in progress leads to missing or faulty firmware. Take special care not to disconnect the power supply while the update is in progress. Interrupting the power supply during the firmware update can lead to an unusable instrument which needs to be sent in for maintenance.

Start the update with the "Execute" softkey.

The installation process starts the update of the front controller first, followed by the update of the interfaces. A progress bar provides information on the current state.

The R&S NPA reboots when the firmware update is completed.

11.2 Interface

The R&S NPA provides several interfaces to establish a remote control connection.

See [Chapter 12, "Network operation and remote control"](#), on page 162, and [Chapter 12.2, "Remote access settings"](#), on page 170.

11.3 Miscellaneous

The miscellaneous menu provides access to instrument information and to basic instrument settings, e.g. to configure date and time, the screen display or CSV file settings. You can individually adjust the settings according to personal preferences and requirements.

Access:

1. Press the [SETUP] key on the front panel.
2. In the setup menu, press the "Misc" softkey.

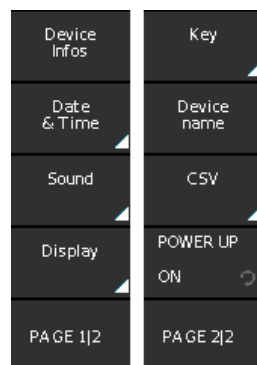

Figure 11-6: Miscellaneous softkey menu

11.3.1 Device information

To get an overview on the configuration of your instrument, you can retrieve information on the instrument model, its hardware components and interfaces using the device information function.

Access:

1. Press the [SETUP] key on the front panel.
2. In the setup menu, press the "Misc" softkey.

3. In the miscellaneous menu, select "Device Infos".

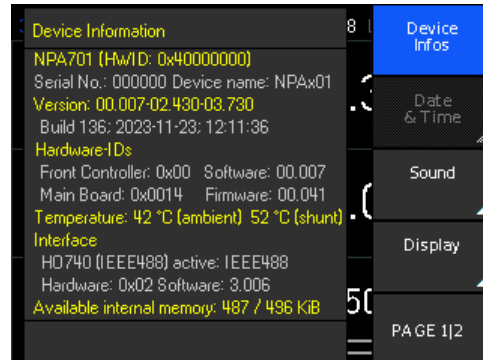



Figure 11-7: Instrument information

The "Device Information" window shows the characteristics of the instrument assemblies. It also indicates the remaining available internal memory.

To return to the previous level

- ▶ Press the  key.

In menus, the back key returns to the previous level or folds it down to a small menu (toggle function).

Settings

[Device Information](#)..... 150

Device Information

Displays the main instrument information.

"<instrument model> (<HW ID:xxx)"

Designation of the instrument and its hardware identification number.

"Serial No.:" Serial number of the instrument.

"Version" Currently installed firmware version.

How to: see [Chapter 11.1, "Update \(firmware\)"](#), on page 146

"Build" Version of the firmware package with time stamp.

"Hardware IDs"

Installed hardware modules, software and firmware versions.

"Temperature" Current ambient temperature and operating temperature of the shunt.

"Interface" Information on the set remote control interface, including hardware ID and software version.

"Available internal memory"

Available amount of memory.

Remote command:

[*IDN?](#) on page 186

[SYSTem:VERSion?](#) on page 236

11.3.2 Date and time

Using the "Date & Time" function, you can set the date and time of the internal instrument clock.

During operation, the R&S NPA records the measurement and creates a time stamp for printed outputs or saved datasets.

Access:

1. Press the [SETUP] key on the front panel.
2. In the setup menu, press the "Misc" softkey.
3. In the miscellaneous menu, select "Date & Time".

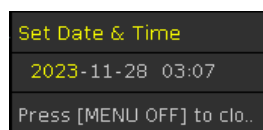

Figure 11-8: Date and time setting

The "Date & Time" entry field contains the date and time setting of the operating system. You can update or modify this setting individually.

The required remote commands are described in [Chapter 13.14, "SYSTEM subsystem"](#), on page 230.

How to: see [Chapter 3.1.12, "Configuring the initial instrument settings"](#), on page 29.

Settings

Date	151
Time	151

Date

Sets the date in the format [yyyy.mm.dd].

Remote command:

[SYSTEM:DATE](#) on page 232

Time

Sets the time in the format [hh.mm.ss].

Remote command:

[SYSTEM:TIME](#) on page 235

11.3.3 Sound

The R&S NPA provides the option for issuing an acoustic signal if there is an error, or as a control measure.

Access:

1. Press the [SETUP] key on the front panel.
2. In the setup menu, press the "Misc" softkey.
3. In the miscellaneous menu, press the "Sound" softkey.



Figure 11-9: Sound settings

4. Enables the acoustic signals with "CTRL BEEP" and "ERROR BEEP" > "On" (toggle function).
5. Return with the  key.

The required remote commands are described in [Chapter 13.14, "SYSTEM subsystem"](#), on page 230.

Settings

Error Beep	152
CTRL Beep	152

Error Beep

Generates an acoustic signal when an error occurs.

"On" Beeps on error.

"Off" No beep.

Remote command:

[SYSTEM:BEEPper:STATe](#) on page 232

CTRL Beep

Beeps immediately when the instrument receives a remote control command.

"On" Beeps on received control command.

"Off" No beep.

Remote command:

[SYSTEM:BEEPper\[:IMMediate\]](#) on page 232

11.3.4 Display settings

The R&S NPA enables you to customize the appearance of the screen in brightness and contrast. You can also adjust the grid intensity for graphical display.

Access:

1. Press the [SETUP] key on the front panel.

2. In the setup menu, select the "Misc" softkey.
3. In the miscellaneous menu, press the "Display" softkey.

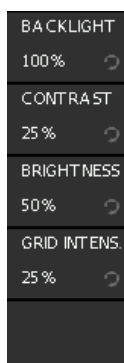

Figure 11-10: Display settings

4. Continue with [To customize the screen intensity](#) and [To customize the grid intensity](#), if applicable.

The "Display" dialog contains the softkey menu for configuring the screen brightness and contrast of the screen, and, optionally, the grid for graphical representation.

To customize the screen intensity

Access:

1. Select [SETUP] > "Misc" > "Display".
2. Select "BLACKLIGHT" to enable edit mode for the parameter.

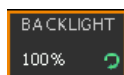

Figure 11-11: Blacklight key

3. Turn the rotary knob to set the black light percentage.
Decreasing the percentage increases the black light.
4. Proceed the same way to adjust the "CONTRAST" and "BRIGHTNESS" of the screen display.

To customize the grid intensity

Instrument models R&S NPA501(-G) / R&S NPA701(-G)

Access:

1. Select [SETUP] > "Misc" > "Display".
2. In the display menu, press the "GRID INTENS." softkey to enable edit mode.
3. Turn the rotary knob to set the intensity in percent.

To return to the previous level

- ▶ Press the  key.

In menus, the back key returns to the previous level or folds it down to a small menu (toggle function).

Settings

Brightness.....	154
Contrast.....	154
Grid Intensity.....	154

Brightness

Sets the brightness of the display in percent.

Range: 10 % to 100 %

Remote command:

n.a.

Contrast

Sets the contrast of the display in percent.

Range: 10 % to 100 %

Remote command:

n.a.

Grid Intensity

Sets the intensity of the display for the graphical representation in percent.

Range: 10 % to 100 %

Remote command:

n.a.

11.3.5 Key brightness

The R&S NPA enables you to customize the brightness of the keys. You can also determine the fallback time. When this time has expired, the instrument accepts a changed value and exits the setting dialog automatically.

Access:

1. Press the [SETUP] key on the front panel.
2. Select the "Misc" softkey.
3. Select "PAGE 1|2" to access the second page of the softkey menu.



Figure 11-12: Key settings

4. To set the key brightness, proceed as described in [To set the key brightness](#).
5. To set the fallback time, see [To set the fallback time](#).

To set the key brightness

Access:

1. Select [SETUP] > "Misc" > "PAGE 1/2".
2. Press the "Key" softkey.
3. Press the "KEY BRIGHT." softkey to enable edit mode.

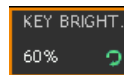

Figure 11-13: Brightness key

4. Turn the rotary knob to set the brightness in percent.
5. To confirm the setting, press the rotary knob.

To set the fallback time

Access:

1. Select [SETUP] > "Misc" > "PAGE 1/2".
2. Press the "Key" softkey.
3. Press the "FALLBACK" softkey to enable edit mode.

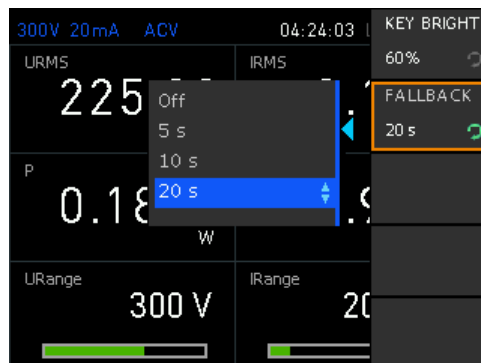



Figure 11-14: Fallback key

4. Select the fallback time with the rotary knob.

- To confirm the settings, press the rotary knob or wait until R&S NPA closes the list automatically.

To return to the previous level

- ▶ Press the  key.

In menus, the back key returns to the previous level or folds it down to a small menu (toggle function).

Settings

KEY BRIGHT.....	156
FALLBACK.....	156

KEY BRIGHT.

Sets the intensity of the key illumination in percent.

Range: 10 % to 100 %

Remote command:

n.a.

FALLBACK

Sets the "Key Fallback Time". This parameter determines the time period the instrument waits before it automatically assigns a changed value. If you confirm the setting manually before the fallback time expires, the setting has no effect.

"5s", "10s", "20s"

Sets the corresponding time period.

"Off" Disables the function.

Remote command:

n.a.

11.3.6 Device name

Access:

- Press the SETUP key on the front panel.
- In the setup menu, press the "Misc" softkey.
- In the miscellaneous menu, select "Device name".

The R&S NPA opens a keypad to assign a name to the instrument.

To assign a name to the instrument

Access:

- Select [SETUP] > "Misc" > "Device name".



Figure 11-15: Device name softkey

- In the "Enter the device name" window, select a character with the rotary knob.

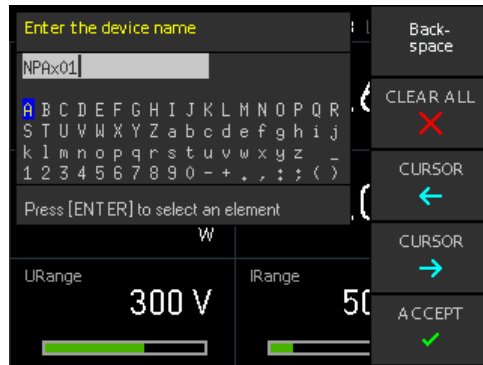

Figure 11-16: Device name

- Confirm with the "Press [ENTER] to select an element" button.
- Repeat the steps until you have completed the name.
- For navigation, use the "CURSOR" softkeys.
- For corrections, use the "Backspace" and "CLEAR ALL" softkeys.
- Complete the entry with the "Accept" softkey.

The "Device name" is assigned. The R&S NPA indicates the assigned device name in the device information window, see [Chapter 11.3.1, "Device information"](#), on page 149.

Settings

[Device name](#)..... 157

Device name

Sets device name.

Remote command:
n.a.

11.3.7 CSV

The "CSV" softkey provides access to the standard "CSV" softkey menu, see [Chapter 11.3.7.2, "CSV settings"](#), on page 158. In this menu, you can define the table separators and decimal floating point for the data, saved in standard *.csv or .txt file format.

11.3.7.1 About CSV

The R&S NPA enables you to record measurement readings and save the data in a file for subsequent evaluation and validation. Recorded data consists of character strings that list general metadata, as, e.g., date, device name, etc., the parameter names and the acquired measurement values.

The standard file formats `*.csv` or `.txt` the R&S NPA saves the data, allow you to use a spreadsheet application program for analysis and evaluation. A spreadsheet program displays the data either as numerals and text, or in graphical form.

Consideration on data content depending on the used application

During a measurement, gaps can occur due to high process load, measurement speed or exceeding file size. It can also occur that a measured parameter was not displayed caused by configuration or exceeded ranges. The gaps result in empty cells designated as "nan" (not a number).

Consider, that not all spreadsheet applications can evaluate "nan" as a 0, which leads to erroneous results, shown in the example.

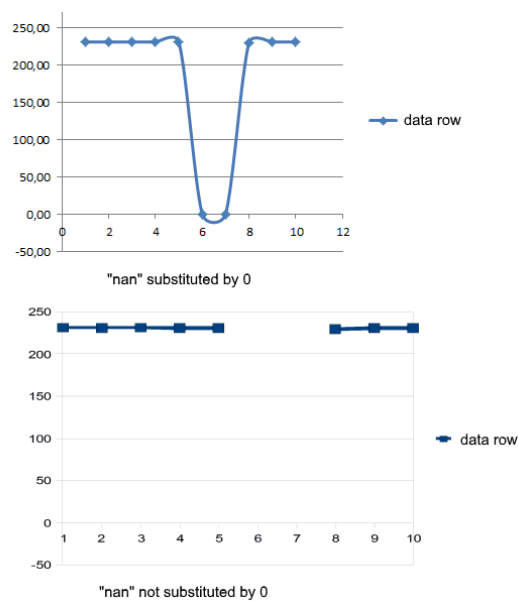

Figure 11-17: "nan"- with correct and erroneous empty cell evaluation

Therefore, the R&S NPA provides a correction function that fills empty cells with 0. Consider the capability of the application you use, and set the function correction correspondingly, see ["ERROR VAL."](#) on page 159.

11.3.7.2 CSV settings

Access:

1. Press the [SETUP] key on the front panel.

2. In the setup menu, press the "Misc" softkey.
3. In the miscellaneous menu, press the "PAGE 1|2" softkey.
4. Press the "CSV" softkey.



Figure 11-18: CSV softkey

The instrument opens a softkey menu for configuring the data separators in the *.CSV file.

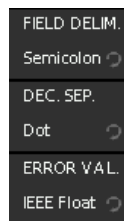

Figure 11-19: CSV softkey menu

Settings

CSV.....	159
FIELD DELIM.....	159
DEC. SEP.....	159
ERROR VAL.....	159

CSV

Opens the "CSV" softkey menu for setting the data separators.

FIELD DELIM.

Selects the line separator between individual parameters or values.

"Semicolon" Separates the data entries by a semicolon.

"Comma" Uses a comma.

Remote command:

n.a.

DEC. SEP.

Selects the decimal separator for values.

"Dot" Sets a decimal point.

"Comma" Uses a comma.

Remote command:

n.a.

ERROR VAL.

Selects whether an empty cell is filled with 0.

"IEE Float" Fills empty cells with 0.

"Empty" Leaves empty cells.

Remote command:

n.a.

11.4 Power up

The power up function enables you to select the start up behaviour of the instrument in the event of a power failure.

Access:

1. Press the [SETUP] key on the front panel.
2. In the setup menu, select "Misc" > "Page 1/2".
3. Select "Power up".

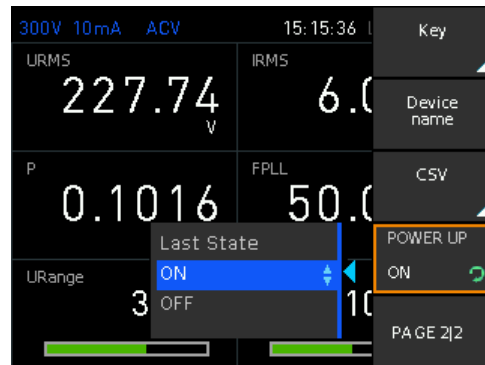

Figure 11-20: Power up menu

The R&S NPA opens a selection list for setting the power up behavior of the instrument.

Settings

[Power up](#)..... 160

Power up

Sets the power up mode after accidental loss of AC power.

Last state Default setting. When the AC power supply is restored, the R&S NPA restarts when it was switched on before the AC power loss. Otherwise, it switches to standby mode.

On The R&S NPA restarts when AC power is supplied.

Off The R&S NPA switches to standby mode when AC power is supplied.

Remote command:

n.a.

11.5 Default

The R&S NPA resets all the miscellaneous settings to default settings with the exception of [date and time](#) and [device name](#) settings.

Access:

1. Press the [SETUP] key on the front panel.

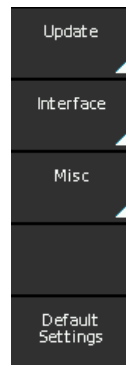

Figure 11-21: Setup softkey menu

2. In the setup softkey menu, select "Default Settings".

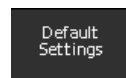

Figure 11-22: Default settings softkey

The R&S NPA resets all miscellaneous settings except of the settings date, time and device name.

The remote commands required to define these settings are described in [Chapter 13.2, "Common commands"](#), on page 185.

Settings

[Default Settings](#)..... 161

Default Settings

Resets the miscellaneous settings to default except of [date and time](#) and [device name](#).

Remote command:

*[RST](#) on page 187

12 Network operation and remote control

As an alternative to operating the instrument directly from the front panel, you can operate the R&S NPA remotely, for example from a controller PC.

The interfaces of the R&S NPA provide flexible access to the instrument. [Figure 12-1](#) shows the possibilities of the physical connection (interfaces) for remote access..



The following descriptions provide information required for operating the R&S NPA remotely. The information applies to all applications and operating modes supported by the instrument. Definitions specified in the SCPI standard are not provided.

For basic knowledge on remote control operation and additional information, see the following documents available from the Rohde & Schwarz website:

- [Remote control via SCPI](#)
- [1MA171: How to use Rohde & Schwarz Instruments in MATLAB](#)
- [1SL374: How to communicate with R&S devices using VISA](#)
- [Rohde-Schwarz - Remote control examples](#)

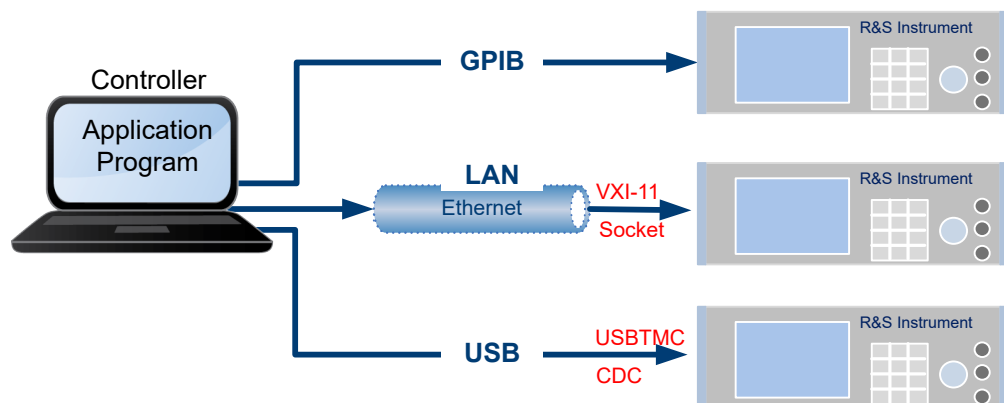

Figure 12-1: Supported remote connections

- [Remote control interfaces and protocols](#)..... 162
- [Remote access settings](#)..... 170
- [Connecting the R&S NPA for remote access](#)..... 176
- [Adjusting the interface addresses](#)..... 177
- [Starting and stopping remote control](#)..... 182

12.1 Remote control interfaces and protocols

The R&S NPA comes with the following interfaces for remote control:

- USB TMC and USB VDC interface
- Ethernet (LAN) interface

- IEE-488 bus interface (GPIB) (instrument models R&S NPA501-G and R&S NPA701-G)



You can only communicate with the instrument over one of the available interfaces at a time.

You need a connection between the R&S NPA and the controller PC. An application software that supports communication over the used interfaces must be installed on the controller PC. [Table 12-1](#) gives an overview on the connectivity:

Table 12-1: Remote control interfaces and protocols

Interface	Protocols, VISA ^{*)} address string and library	Remarks
Local area network (LAN)	<ul style="list-style-type: none"> • VXI-11 TCPIP::<host address="">:: LAN device name]>::INSTR] VISA</host> • Socket communication (Raw Ethernet, simple Telnet) TCPIP::<host address="">:: LAN device name]::<port>::SOCKET VISA or socket controller</host> 	<p>The LAN connector is on the rear panel of the instrument.</p> <p>The interface is based on TCP/IP, see Chapter 12.1.1, "LAN interface", on page 164.</p>
USB	<ul style="list-style-type: none"> • USBTMC USB::<vendor ID>::<product ID>:: <serial number>[::INSTR] VISA • CDC (communications device class, corresponds to VCP (virtual COM port)) 	<p>The USB B connector is on the front panel.</p> <p>For a description of the interface, refer to Chapter 12.1.2, "USB interface", on page 165</p>
GPIB (IEC/IEEE Bus Interface) (instrument models R&S NPA501-G), R&S NPA701-G)	<ul style="list-style-type: none"> • – GPIB::<address>[::INSTR] (no secondary address) VISA (optional) 	<p>The GPIB bus interface according to standard IEC 625.1/IEEE 488.1 is on the rear panel.</p> <p>For a description of the interface, see Chapter 12.1.3, "GPIB interface (IEC/IEEE bus interface)", on page 166.</p>

^{*)} VISA (Virtual Instrument Software Architecture) is a standardized software interface library providing input and output functions to communicate with instruments. A VISA installation on the controller is a prerequisite for remote control over LAN and USB interface. For remote control over socket communication VISA installation is optional. When using socket communication or the GPIB interface, VISA installation is optional. For basic information, see [Remote control via SCPI](#).



Rohde & Schwarz provides the standardized I/O software library R&S VISA for download on the Rohde & Schwarz website <http://www.rohde-schwarz.com/rsvisa>.

- [LAN interface](#)..... 164
- [USB interface](#)..... 165
- [GPIB interface \(IEC/IEEE bus interface\)](#)..... 166
- [Status reporting system](#)..... 167

12.1.1 LAN interface

For remote control via a network, the PC and the instrument must be connected over the LAN interfaces to a common network with TCP/IP network protocol. The instruments are connected with a commercial RJ45 cable, see "[Cable selection and electro-magnetic interference \(EMI\)](#)" on page 21.

The TCP/IP network protocol and the associated network services are preconfigured on the instrument. Software for instrument control and (for specified protocols only) the VISA program library must be installed on the controller.



Identifying instruments in a network

If several instruments are connected to the network, each instrument has its own IP address and associated resource string. The controller identifies these instruments by the resource string.

12.1.1.1 VISA resource strings

The VISA resource string is required to establish a communication session between the controller and the instrument in a LAN. The resource string is a unique identifier, composed of the specific IP address of the instrument and some network and VISA-specific keywords.

`TCPIP::::<LAN device name>[:INSTR]`

TCPIP	= designates the network protocol
host address	= designates the IP address or hostname of the instrument
[:LAN device name]	= defines the protocol and the instance number of a subinstrument
[:INSTR]	= indicates the instrument resource class (optional)

The **IP address** (host address/computer name) is used by the programs to identify and control the instrument. It is automatically assigned by the DHCP server the first time the device is registered on the network.

The R&S NPA indicates the IP address in the "Ethernet Settings" dialog, see [Chapter 12.2.2, "Ethernet settings"](#), on page 172, which also provides to adjust the IP address manually.

VXI-11

`TCPIP::::inst0[:INSTR]`

[:inst0] = LAN device name, indicates that the VXI-11 protocol is used (optional)

[::inst0] selects the VXI-11 protocol by default and can be omitted.

Example:

`TCPIP:::192.1.2.3::INSTR`

Socket communication

TCPIP::[host address](#)::[port](#)::SOCKET

TCPIP = designates the network protocol
host address = designates the IP address or hostname of the instrument
port = determines the used port number
SOCKET = indicates the raw network socket resource class

Socket communication requires the specification of the port (commonly referred to as port number) and of "SOCKET" to complete the VISA resource string with the associated protocol used.

The registered port for socket communication is port 5025.

Example:

```
TCPIP::192.1.2.3::5025::SOCKET
```

To assign the address, see [Chapter 12.4.1, "How to configure the Ethernet settings"](#), on page 177.

12.1.2 USB interface

For remote control over the USB connection, the PC and the instrument must be connected over the USB B interface.

The USB B connector is on the [rear panel](#) of the instrument.

On the controller, you need to install any application for instrument control, for example the R&S HME Explorer, and if available, a VISA program library. VISA detects and configures the Rohde & Schwarz instrument automatically when the USB connection is established.

You can communicate with the instrument over the USB TMC class or the CDC class protocols:

- **CDC**
(Communications Device Class, also known as VCP virtual COM port) is a protocol used for emulating serial ports over USB. Using the CDC protocol, you have to install the USB VCP driver and activate it in the PC device explorer. The driver is available for download on the Rohde & Schwarz product site at www.rohde-schwarz.com/driver/npa/. For installation of the driver, you need administrator rights.
To select the USB class, see [Chapter 12.2.1, "USB settings"](#), on page 171..
- **USBTMC**
(USB Test & Measurement Class Specification) is a protocol that is built on top of USB for communication with USB devices, like GPIB. It defines class code information of the instrument, that identifies its functionality to load the respective device driver. Using VISA library, it supports service request, triggers, and other specific operations, similar to GPIB.

For control, you can use the SCPI terminal function of the R&S HMExplorer software. This software also provides logging of measurement values, or graphical display.

USB resource string

The resource string represents an addressing scheme that is used to establish a communication session with the instrument. It is based on the instrument address and some instrument- and vendor-specific information.

The USB resource string syntax is as follows:

USB::<vendor ID>::<product ID>::<serial number>[:INSTR]

USB	= denotes the used interface
<vendor ID>	= is the manufacturer ID for Rohde & Schwarz
<product ID>	= is the product identification of the instrument
<serial number>	= is the individual serial number on the rear of the instrument
[:INSTR]	= indicates the instrument resource class (optional)

Example:

USB::0x0AAD::0x01DD::100001

0x0AAD is the vendor ID for Rohde & Schwarz.

0x01DD is the product ID for the R&S NPA

100001 is the serial number of the particular instrument.

See [Chapter 12.4.3, "How to configure the USB connection"](#), on page 181.

12.1.3 GPIB interface (IEC/IEEE bus interface)

R&S NPA-G models are equipped with a GPIB interface. The GPIB interface is on the [rear panel](#).

To control the instrument over the GPIB bus interface, the instrument and the controller must be connected with a GPIB bus cable. A GPIB bus card, the card drivers and the program libraries for the programming language used must be provided in the controller.



See [Remote control via SCPI](#) for additional information on the characteristics, control commands and messages of the GPIB interface.

GPIB address

The controller addresses the instrument within the GPIB bus channel. GPIB provides channel addresses from 0 to 30. The GPIB address is preset to 1 (factory-set), but you can adjust it according to your network environment, see [Chapter 12.2.3, "GPIB settings"](#), on page 175. An instrument preset or setting to default does not affect the GPIB address.

`GPIB::<channel>[::INSTR]`

GPIB = denotes the used interface
<channel address> = the used channel
[::**INSTR**] = indicates the instrument resource class (optional)



If the VISA implementation supports the GPIB interface, you can optionally define the VISA Instrument Control Resource (INSTR). It is used to define the basic operations and attributes for a device, such as reading, writing, or triggering.

Example:

`GPIB : : 28`

28 is the selected GPIB bus channel.

To change the GPIB address, see [Chapter 12.2.3, "GPIB settings"](#), on page 175.

12.1.4 Status reporting system

The status reporting system saves all information on the current operating state of the instrument, and on errors which have occurred. This information is saved in the status registers and in the error queue. You can query the status of the registers remotely, i.e. over the USB, GPIB or LAN interfaces with the commands of the [Chapter 13.13, "Status subsystem"](#), on page 227.

12.1.4.1 Overview of the R&S NPA status registers

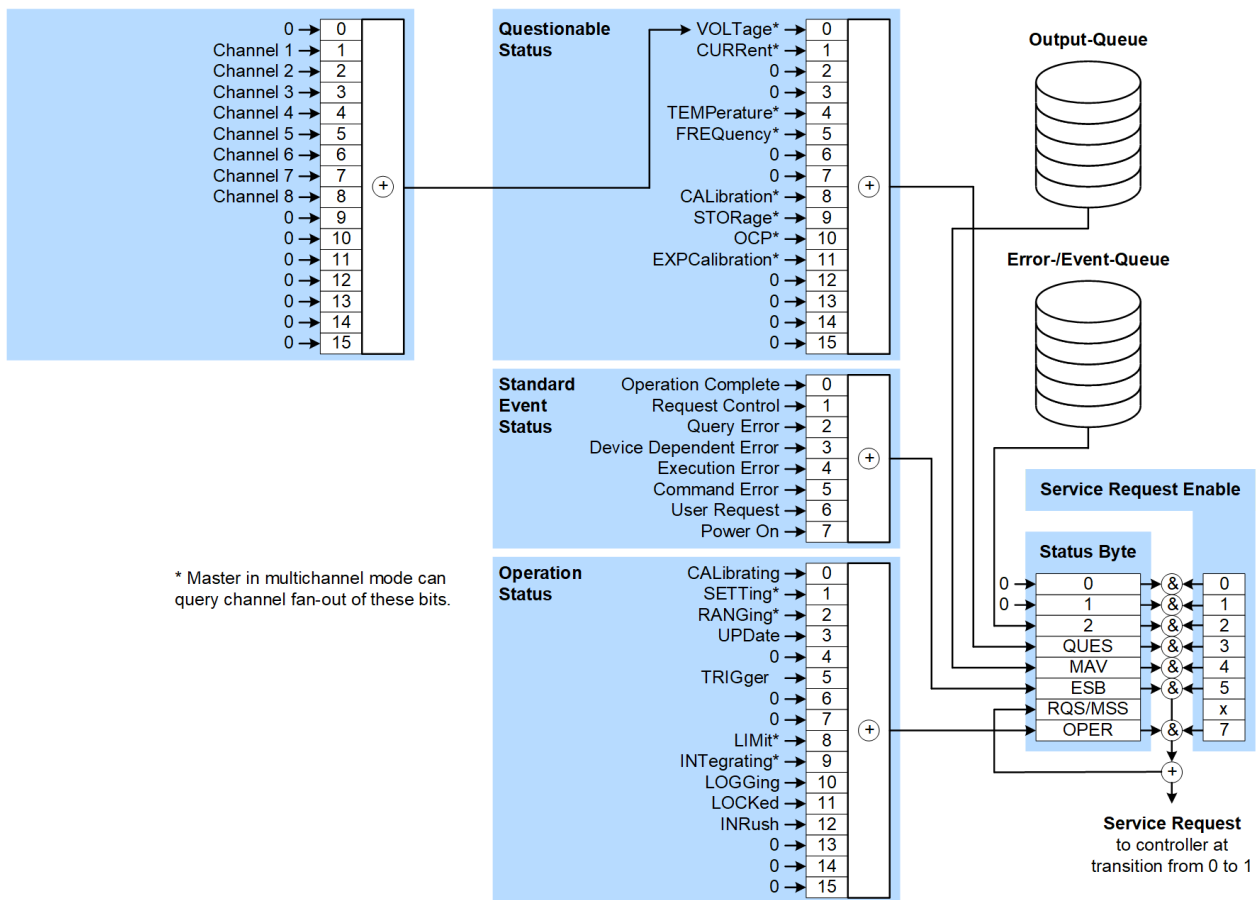

Figure 12-2: Graphical overview of the status registers



The following sections describe the instrument-specific bit assignments of the operation status and the questionable status registers.

For more information, see:

- [Remote control via SCPI](#): provides general information on the status reporting system of Rohde & Schwarz instruments. This document also provides information on the standard event status register and the error queue.
- [Chapter 13.13, "STATUS subsystem"](#), on page 227: describes the corresponding remote control commands of the status register
- SCPI standard documentation for comprehensive information on the standard

12.1.4.2 Instrument-specific status questionable register

This status register contains information on questionable instrument states. Questionable states occur when the instrument is not operated in compliance with its specifications.

To read the register, use the commands `STATUS:QUESTIONABLE:CONDITION?` and `STATUS:QUESTIONABLE[:EVENT]?`. The remote commands for the status questionable register are described in [Chapter 13.13.2, "Status questionable register"](#), on page 229.

Table 12-2: Assignment of the bits used in the questionable status register

Bit No.	Meaning
0	VOLTage This bit is set when voltage overrange occurs.
1	CURRent This bit is set when current overrange occurs.
2 to 3	Not used
4	TEMPerature overrange This bit is set when the temperature is exceeded.
5	FREQuency This bit is set when frequency overrange occurs.
6 to 7	Not used
8	CALibrating
9	STORage This bit is set when instrument stores data.
10	OCP This bit is set when the over current protection is enabled.
11	EXPCalibration This bit is set when calibration is no longer valid.
12 to 15	Not used

See the schematic representation [Figure 12-2](#).

12.1.4.3 Instrument-specific status operation register

The condition part contains information on currently executed actions. The event part covers information on the actions performed since the last readout of the register.

To read the register, use the query commands `STATUS:OPERATION:CONDITION?` and `STATUS:OPERATION[:EVENT]?`. The remote commands for the status operation register are described in [Chapter 13.13.1, "Status operation register"](#), on page 228.

Table 12-3: Assignment of the bits used in the operation status register

Bit No.	Meaning
0	CALibrating The bit is set during the calibration phase (for service department only).
1	SETTing

Bit No.	Meaning
2	RANGing
3	UPDate
4	Not used
5	TRIGger This bit is set while the instrument is waiting for the trigger.
6 to 7	Not used
8	LIMit
9	INTegrating
10	LOGGing
11	LOCKed Instrument locked (RWLock)
12	INRush
13 to 15	Not used

See the schematic representation [Figure 12-2](#).

12.2 Remote access settings

The "Interface" softkey menu provides access to the settings that address the instrument, including its specific identification parameters and parameters required for the corresponding interfaces.

Access:

- ▶ Select [SETUP] > "Interface".



Figure 12-3: Interface softkey menu

The "Interface" softkey menu enables you to access the setting parameters of the interfaces the instrument is equipped with.

To return to the previous level

- ▶ Press the  key.

In menus, the back key returns to the previous level or folds it down to a small menu (toggle function).

12.2.1 USB settings

For remote control over USB, you can address the R&S NPA over the USB TMC class, or the virtual COM port CDC (VCP).

Access:

1. Select [SETUP] > "Interface".
2. In the "Interface" softkey menu, select the "USB" port, e.g. "USB VCP".



Figure 12-4: USB VCP selection

The R&S NPA enables the connection and indicates the selected USB interface in the status bar.

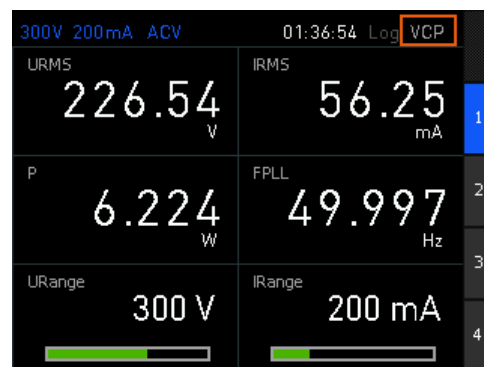

Figure 12-5: USB VCP display on the screen

Note: If you have established the USB connection to the controller PC, and the required VCP driver or the VISA interface library is missing, the PC operating system displays the "Found New Hardware Wizard" notification.

If a connection between PC and the instrument has been established and no R&S NPA USB-VCP driver is installed, the PC operating system displays a "Found New Hardware" wizard. In this case, the R&S NPA USB-VCP driver must be installed.

See [Chapter 12.1.2, "USB interface"](#), on page 165.

How to: [Chapter 12.4.3, "How to configure the USB connection"](#), on page 181

USB VCP	172
USB TMC	172

USB VCP

Selects the CDC protocol for controlling the R&S NPA remotely over the USB VCP interface.

USB TMC

Selects the USBTMC connection for remote control over USB.

Remote command:

`SYSTEM:INTerface` on page 234

12.2.2 Ethernet settings

Access:

1. Select [SETUP] > "Interface".
2. In the "interface" softkey menu, select the "Ethernet" softkey.



Figure 12-6: Ethernet selection

3. Select the "Parameter" softkey to access the "Ethernet Settings" dialog.

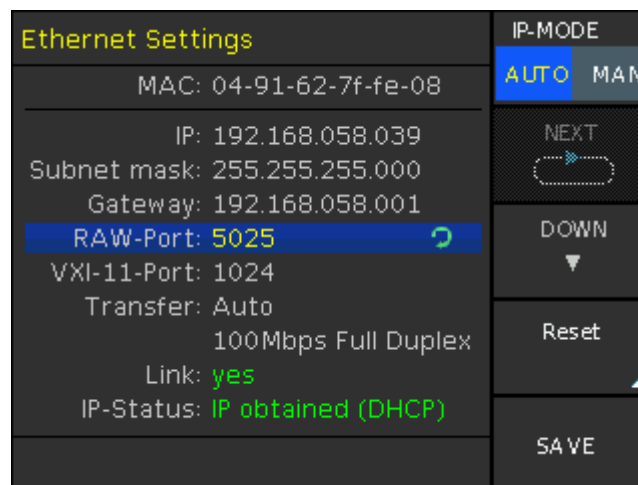

Figure 12-7: Ethernet settings dialog

In this dialog, you can configure the settings of the general network environment and specific identification parameters of the instrument in the network. The R&S NPA displays the VISA resource strings and additional parameters for information on the LAN interface, and the status of the connection.

By default, the R&S NPA is configured to use dynamic TCP/IP configuration and to obtain the whole address information automatically. If the network does not support DHCP, you can assign the IP address manually.

How to: ["To assign the IP addresses for the LAN interface manually"](#) on page 177.

ETHERNET	173
MAC	173
IP Mode	173
IP	173
Subnet mask	173
Gateway	174
RAW-Port	174
VXI-11-Port	174
Transfer	174
Link	174
IP-Status	174
Reset	175
Save	175

ETHERNET

Selects the LAN interface for controlling the R&S NPA remotely.

Remote command:

[SYSTem: INTerface](#) on page 234

MAC

Indicates the MAC (Media Access Control) address, a unique identifier of the network adapter in the R&S NPA.

Remote command:

n.a.

IP Mode

Selects the mode for assigning the IP address.

How to: [Chapter 12.4, "Adjusting the interface addresses"](#), on page 177.

"Auto (DCHP)"

Assigns the IP address automatically, provided the network supports DHCP.

"MAN"

Enables you to assign the IP address manually.

Remote command:

n.a.

IP

Displays the IP address of the instrument in the network.

To assign the IP address manually, select [IP Mode > MAN](#).

Remote command:

n.a.

Subnet mask

Displays the bit group of the subnet in the host identifier.

To assign the subnet mask manually, select [IP Mode > MAN](#).

Remote command:
n.a.

Gateway

Displays the gateway address.

This address identifies the router on the same network as the instrument that is used to forward traffic to destinations beyond the local network.

To assign the "Gateway" manually, select [IP Mode > MAN](#).

Remote command:
n.a.

RAW-Port

Displays the visa resource string for remote control over LAN, using TCP/IP socket protocol.

To assign the socket port manually, select [IP Mode > MAN](#).

Remote command:
n.a.

VXI-11-Port

Displays the visa resource string for Ethernet instruments.

Remote command:
n.a.

Transfer

Selects the mode to determine the parameters of the communication channel.

Auto Determines the parameters automatically.

"Manual 10/100Mbps Half Duplex"

Sets 10/100Mbps data transfer in one direction on the communication channel.

"Manual 10/100Mbps Full Duplex"

Sets 10/100 Mbps data transfer in both directions on the communication channel.

Remote command:
n.a.

Link

Displays the status of the LAN connection. "Yes" in green letters denotes that the LAN is active.

Remote command:
n.a.

IP-Status

Indicates whether the LAN connection is active (green color), and displays the setting of the IP mode.

Remote command:
n.a.

Reset

Restores the LAN settings to factory default.

"Confirm" Confirm the factory default settings.

"Abort" Aborts the factory default settings.

Save

Saves the static IP settings.

12.2.3 GPIB settings

Instrument models R&S NPA501-G and R&S NPA701-G are equipped with an integrated GPIB IEEE488 bus interface.

Access:

1. Select [SETUP] > "Interface".
2. In the interface menu, select "IEEE488".



Figure 12-8: IEEE488 selection

3. Select "PARAMETER" to access the "IEEE488" softkey menu.



Figure 12-9: IEEE488 softkey menu

4. Select the "Address" softkey.
5. Enter the address with the rotary knob or the numeric keypad.
6. Confirm with "Save".

The controller must address the instrument with the GPIB bus address.

How to: [Chapter 12.4.2, "How to change the GPIB address"](#), on page 180.

To return to the previous level

- ▶ Press the  key.

In menus, the back key returns to the previous level or folds it down to a small menu (toggle function).

IEEE488.....	176
PARAMETER.....	176
Address.....	176
Save.....	176

IEEE488

Selects the GPIB bus interface for reemote control of the R&S NPA.

Remote command:

[SYSTem:INTerface](#) on page 234

PARAMETER

Selects the GPIB interface parameter.

Remote command:

n.a.

Address

Sets the GPIB address.

Remote command:

n.a.

Save

Confirms the setting.

Remote command:

n.a.

12.3 Connecting the R&S NPA for remote access

12.3.1 Connecting to LAN

For remote control of the R&S NPA in a LAN, connect the instrument as described in [Chapter 3.1.8, "Connecting to LAN"](#), on page 24.

12.3.2 Connecting the R&S NPA to the USB interface

You can use the USB B interface for remote control and data transfer from a controller PC. Remote control over USB requires the VISA library.

The USB B connector is on the [rear panel](#).

To connect the R&S NPA to the USB B interface:

- ▶ Connect the USB B connector using a double-shielded USB cable to the controller PC.

VISA detects and configures the instrument automatically when the USB connection is established. You do not have to enter an address string or install a separate driver.

12.3.3 Connecting the R&S NPA to the IEC 625/IEEE 488 interface

Instrument models R&S NPA501-G R&S NPA701-G provide the GPIB bus interface, you can use for controlling the instrument remotely.

The USB B connector is on the [rear panel](#).

To connect the R&S NPA to the controller PC:

1. Connect the IEC 625/IEEE 488 connector of the R&S NPA to the controller PC with a double-shielded GPIB bus interface cable.
2. Enable the remote control connection as described in [Chapter 12.2.3, "GPIB settings"](#), on page 175.

The controller must address the instrument with the GPIB bus address, see [Chapter 12.1.3, "GPIB interface \(IEC/IEEE bus interface\)"](#), on page 166.

12.4 Adjusting the interface addresses

12.4.1 How to configure the Ethernet settings

Depending on the network capabilities, the TCP/IP address information for the instrument can be obtained in different ways.

- If the network supports DHCP (dynamic host configuration protocol), this protocol assigns the IP address automatically (default setting). DHCP mode enables you to establish a physical connection to the LAN without any additional instrument configuration. Regardless of the automatic address configuration, the instrument allows to adjust the interface addresses of the raw socket and the VX-11 ports.
- If the network does not support DHCP or if the instrument is set to use alternate TCP/IP configuration, you must set the addresses manually.

To assign the IP addresses for the LAN interface manually

The following instructions lead you through the steps for setting the IP address manually.

Access:

1. Select [SETUP] > "Interface".
2. Select the "Ethernet" softkey to enable the ethernet connection.



Figure 12-10: ETHERNET softkey

3. Select the "PARAMETER" softkey to access the interface settings dialog.
The R&S NPA displays the information on the LAN interface, and the status of the connection.

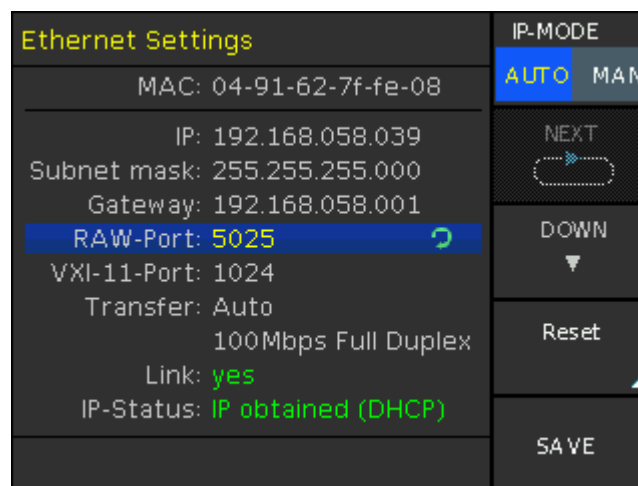

Figure 12-11: Ethernet settings

In this dialog, you can configure the settings of the general network environment and specific identification parameters of the instrument in the network. The MAC address is assigned statically and cannot be modified.

4. **NOTICE!** Risk of network failure. Connecting to the network with an incorrectly configured interface can cause failures that affect the entire network.

Consult your network administrator before performing the following tasks:

- Connecting the instrument to the network
- Configuring the network
- Changing IP addresses

5. Select "IP-MODE" > "MAN" to enable edit mode.



Figure 12-12: IP mode setting

6. Select the "DOWN" softkey repeatedly up to the "IP" address field.
The IP address consists of four blocks separated by dots. Every block contains 3 numbers at a maximum.

- a) Set the first number of the address.
 - b) Select "NEXT" with the rotary knob to step to the following block.
 - c) Set the number.
 - d) Proceed the same way to to complete the address.
7. Select "Down" to continue with the next setting.
 8. Set the "Subnet mask" and "Gateway" in the same way as described above.
 9. Select the "RAW Port" entry field, to set the port number for SCPI socket communication.
 10. Set the "VXI-11- Port" used by the instrument.
 11. Select the "Transfer" mode using the rotary knob.
"Auto" assigns the transfer parameters automatically, or you can set the baudrate and duplex mode ("HALF" / "FULL") manually.
 12. "SAVE" the settings.

The "Link" and "IP-Status" information at the bottom of the dialog indicates whether a LAN connection is established successfully.

To check the LAN connection

You have several possibilities, to validate if the LAN connection is established and working properly:

1. Check the LAN connection using ping: `ping <IP address>`.
2. If the PC can access the instrument, enter the IP address of the instrument into the Internet browser on your computer: `http// :xxx.yyy.zzz.xxx`

The "Device Information" page appears. It provides information on the instrument and the LAN connection.

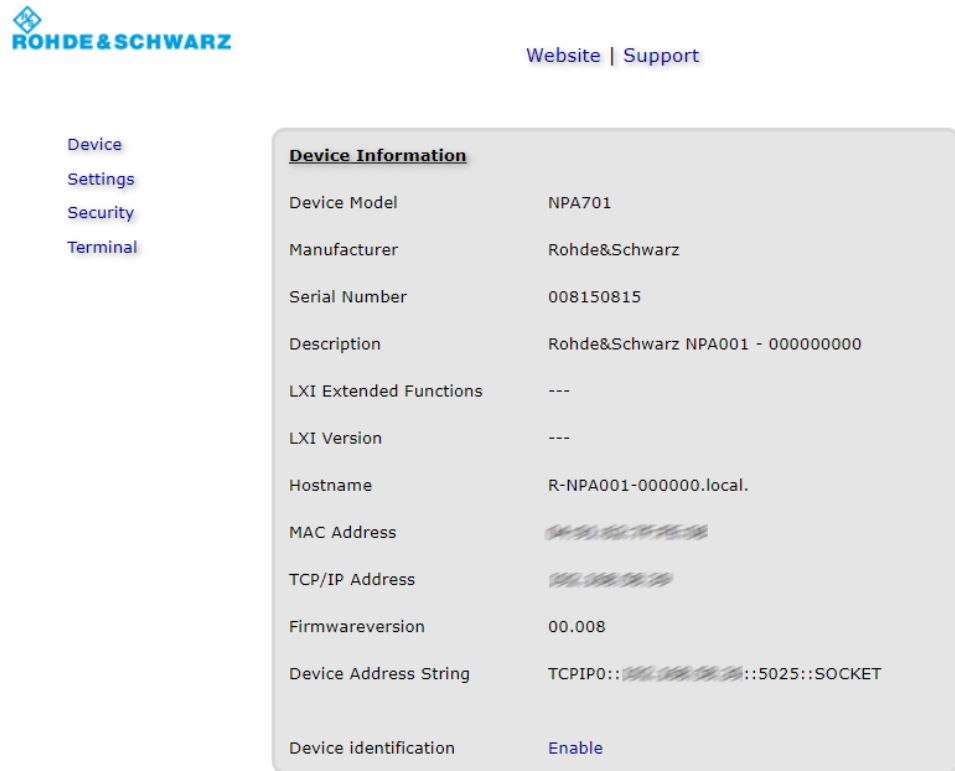

The screenshot shows the R&S NPA web interface. On the left, there is a navigation menu with options: Device, Settings, Security, and Terminal. The main content area displays 'Device Information' with the following details:

Device Information	
Device Model	NPA701
Manufacturer	Rohde&Schwarz
Serial Number	008150815
Description	Rohde&Schwarz NPA001 - 000000000
LXI Extended Functions	---
LXI Version	---
Hostname	R-NPA001-000000.local.
MAC Address	██████████
TCP/IP Address	██████████
Firmwareversion	00.008
Device Address String	TCPIP0::██████████::5025::SOCKET
Device identification	Enable

Figure 12-13: Browser interface Device information

12.4.2 How to change the GPIB address

The controller addresses the instrument within the GPIB bus channel, providing addresses from 0 to 30. The R&S NPA has the factory-set address of 1, which you can adjust according to your environment.

To assign the GPIB (IEEE488) address manually

Access:

1. Press the [SETUP] key on the front panel.
2. Select the "Interface" softkey.
3. Select "IEEE488" in the softkey menu.



Figure 12-14: IEEE488 softkey

4. Select the "PARAMETER" softkey to access the settings of the IEEE488 interface.
5. Select "ADDRESS" to enable edit mode for the address setting.

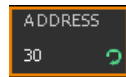



Figure 12-15: Address enabled for editing

6. Set the required address with the rotary knob.
7. Select the "SAVE" softkey to confirm the setting.
8. Return with the  key.

12.4.3 How to configure the USB connection

For remote control over the USB interface, the controller PC and the instrument must be connected over the USB type B interface. The **USB B** connector is on the **front panel**. Depending on the used USB port, the connection requires the VISA library or a USB VCP driver to be installed.

To select the USB VDC communication port

Communication over the virtual COM port requires that you have installed a USB VCP driver on the controller PC.

Access:

1. Select [SETUP] > "Interface".
2. Select the "USB VCP" softkey to enable the communication.



Figure 12-16: USB VCP softkey

You do not have to enter an address string, therefore the "PARAMETER" is grayed out.

3. Return with the  key.

To select the USB TMC communication port

Communication over USB TMC requires that you have installed the VISA library on the controller PC.

Access:

1. Select [SETUP] > "Interface".
2. Select the "USB TMC" softkey to enable communication.

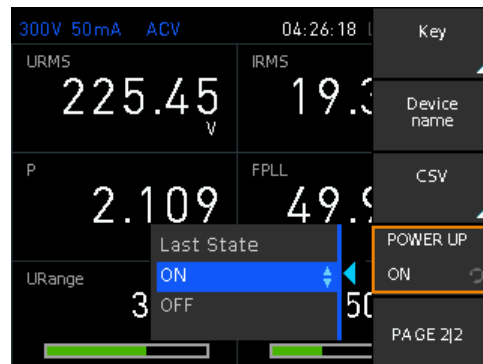

Figure 12-17: USB TMC softkey

Communication over USB TMC does not require further address settings, therefore the "PARAMETER" is grayed out.

3. Return with the  key.

12.5 Starting and stopping remote control

When you switch on the instrument, it is always in manual operation state (local state). You can operate it using the controls on the front panel. To switch to remote control operation, proceed as described as follows.

To start a remote control session

1. Send a remote control command from the controller.
2. VXI-11 protocol (LAN or USB interface): send the interface message `>R`.

The instrument switches to remote control and executes the command.

On the screen, a status symbol indicates that remote control is active. The display remains on and you can still operate it manually with the front panel controls.

To lock manual control

To prevent unauthorized access, you can explicitly block the front panel controls.

1. Send the message `>r`.
2. Send the message `>l`.

You can control the instrument remotely only.

3. To release the controls again, send the message `>l`.

To return to manual control

The instrument switches back to manual operation when the remote connection is closed. But you can return to manual operation either manually or remotely.

1. Select "Local" softkey.

2. VXI-11 protocol (LAN or USB interface): send the message `>L`.

The instrument switches to manual control.

13 Remote control commands

In the following, all remote-control commands are presented in detail with their parameters and the ranges of numerical values.

For an introduction to remote control and the status registers, see:

- [Chapter 12, "Network operation and remote control"](#), on page 162
- [Chapter 12.1.4, "Status reporting system"](#), on page 167

See also the list of commands in alphabetical order at the end of this user manual.



The channel suffix is irrelevant for all measurement commands and is therefore not mentioned in the following commands.

13.1 Conventions used in SCPI command descriptions

Note the following conventions used in the remote command descriptions:

- **Command usage**
Unless otherwise specified, you can set and query a parameter with a command. If you can only set or query a parameter with a command, or if a command triggers an event, the use is explicitly specified.
- **Parameter usage**
Unless otherwise specified, you can set and query a value of a parameter. Parameters that only set a value are indicated as **Setting parameters**. Parameters that refine a value are indicated as **Query parameters**. Parameters that are only returned as the result of a query are indicated as **Return values**.
- **Conformity**
Commands that are taken from the SCPI standard are indicated as **SCPI confirmed**. All commands used by the R&S NPA follow the SCPI syntax rules.
- **Asynchronous commands**
A command which does not automatically finish executing before the next command starts executing (overlapping command), is indicated as an **Asynchronous command**.
- **Reset values (*RST)**
Default parameter values that are used directly after resetting the instrument (*RST command) are indicated as ***RST** values, if available.
- **Default unit**
The default unit is used for numeric values if no other unit is provided with the parameter.
- **Manual operation**
If the result of a remote command can also be achieved in manual operation, a link to the description is inserted.

13.2 Common commands

Common commands are described in the IEEE 488.2 (IEC 625-2) standard. These commands have the same effect and are employed in the same way on different devices. The headers of these commands consist of "*" followed by three letters. Many common commands are related to the Status Reporting System.



Rohde & Schwarz recommend to start a program by *RST (see *RST on page 187) in order to set the instrument to a defined status prior to starting a program.

The R&S NPA does not support parallel processing of remote commands. If the query *OPC? (see *OPC on page 186) returns a „1“, the device is able to process new commands.

Available common commands:

*CLS.....	185
*ESE.....	185
*ESR?.....	186
*IDN?.....	186
*LRN?.....	186
*OPC.....	186
*PSC.....	186
*RCL <Storage>.....	187
*RST.....	187
*SAV <Storage>.....	187
*SRE.....	187
*STB?.....	187
*TRG.....	188
*TST?.....	188
*WAI.....	188

*CLS

Clear status

Sets the status byte (STB), the standard event register (ESR) and the `EVENT` part of the `QUESTIONABLE` and the `OPERATION` registers to zero. The command does not alter the mask and transition parts of the registers. It clears the output buffer.

Usage: Setting only

*ESE <Value>

Event status enable

Sets the event status enable register to the specified value. The query returns the contents of the event status enable register in decimal form.

Parameters:

<Value> Range: 0 to 255

0

The contents of the status registers are preserved.

1

Resets the status registers.

***RCL <Storage>**

Recalls the current instrument state from the specified memory location.

Parameters:

<Storage> 0 | 1 | 2 | 3 | 4 | 5 | 6 | 7 | 8 | 9

Manual operation: See "[Load](#)" on page 141

***RST**

Reset

Sets the instrument to a defined default status. The default settings are indicated in the description of commands.

Usage: Setting only**Manual operation:** See "[Default Settings](#)" on page 161

***SAV <Storage>**

Saves the current instrument state in the specified memory location. The command overwrites any previously saved state in the same memory location without error notification.

Parameters:

<Storage> 0 | 1 | 2 | 3 | 4 | 5 | 6 | 7 | 8 | 9

Manual operation: See "[Save](#)" on page 141

***SRE <Contents>**

Service request enable

Sets the service request enable register to the indicated value. This command determines under which conditions a service request is triggered.

Parameters:<Contents> Contents of the service request enable register in decimal form.
Bit 6 (MSS mask bit) is always 0.

Range: 0 to 255

***STB?**

Status byte query

Reads the contents of the status byte in decimal form.

Usage: Query only

***TRG**

Trigger

Triggers all actions waiting for a trigger event. In particular, *TRG generates a manual trigger signal. This common command complements the commands of the TRIGger subsystem.

*TRG corresponds to the INITiate:IMMediate command.

Usage: Event

***TST?**

Self-test query

Initiates self-tests of the instrument and returns an error code.

Return values:

<ErrorCode> **integer > 0 (in decimal format)**

An error occurred.

0

No errors occurred.

Usage: Query only

***WAI**

Wait to continue

Prevents servicing of the subsequent commands until all preceding commands have been executed and all signals have settled (see also command synchronization and *OPC).

Usage: Event

13.3 CHANnel:ACQuisition subsystem

The subsystem contains the commands for configuring data acquisition.

Example: ACQuisition settings

The example represents the remote control commands for configuring the settings for the channel data acquisition.

```

*****
// Acquisition functions and parameter settings
*****

*****
// AC mode
*****

// Configure the parameters:
// select synchronization frequency, e.g.
// select voltage as reference
// activate the freq and bandwidth filters
CHANnel[:ACQuisition]:MODE AC
CHANnel[:ACQuisition]:MODE[:AC]:PLL VOLTage
CHANnel[:ACQuisition]:MODE[:FILTer]:ANALog ON
CHANnel[:ACQuisition]:MODE[:FILTer]:DIGital OFF
CHANnel[:ACQuisition]:MODE[:FILTer]:FREQuency ON

*****
// Query the settings:
CHANnel[:ACQuisition]:MODE?
// Response: AC
CHANnel[:ACQuisition]:MODE[:AC]:PLL?
// Response: VOLTage
CHANnel[:ACQuisition]:MODE[:FILTer]:ANALog?
// Response: 1
CHANnel[:ACQuisition]:MODE[:FILTer]:DIGital?
// Response: 0
CHANnel[:ACQuisition]:MODE[:FILTer]:FREQuency?
// Response: 1

*****
// DC mode
*****

CHANnel[:ACQuisition]:MODE DC

*****
// Query the settings:
CHANnel[:ACQuisition]:MODE?
// Response: DC

*****
// AUTO mode
*****

// Configure the parameters:
// activate all filters

```

```

CHANnel[:ACQuisition]:MODE AUTO
CHANnel[:ACQuisition]:MODE[:FILTer]:ANALog 1
CHANnel[:ACQuisition]:MODE[:FILTer]:DIGital 1
CHANnel[:ACQuisition]:MODE[:FILTer]:FREQuency 1

*****
// Query the settings:
CHANnel[:ACQuisition]:MODE?
// Response: AUTO
CHANnel[:ACQuisition]:MODE[:FILTer]:ANALog?
// Response: 1
CHANnel[:ACQuisition]:MODE[:FILTer]:DIGital?
// Response: 1
CHANnel[:ACQuisition]:MODE[:FILTer]:FREQuency?
// Response: 1

*****
// External mode
*****
CHANnel[:ACQuisition]:MODE EXTErn

*****
// Query the settings:
CHANnel[:ACQuisition]:MODE?
// Response: EXT

*****
// Voltage acquisition settings
*****
// Configure the parameters:
// deactivate autorange
// select the voltage range, crest factor
// deactivate invert function

CHANnel[:ACQuisition]:VOLTage:RANGe:AUTO 0
CHANnel[:ACQuisition]:VOLTage:RANGe 15
CHANnel[:ACQuisition]:VOLTage:CFACTOR 3
CHANnel[:ACQuisition]:VOLTage:INVert 0

*****
// Query the settings:
CHANnel[:ACQuisition]:VOLTage:RANGe:AUTO?
// Response: 0
CHANnel[:ACQuisition]:VOLTage:RANGe?
// Response: 15
CHANnel[:ACQuisition]:VOLTage:CFACTOR?
// Response: 3
CHANnel[:ACQuisition]:VOLTage:INVert?
// Response: 0

```

```
*****
// Current acquisition settings
*****
// Configure the parameters:
// deactivate autorange
// select the current range and crest factor
// activate invert function

CHANnel[:ACQuisition]:CURRent:RANGe:AUTO 0
CHANnel[:ACQuisition]:CURRent:RANGe 0.005
CHANnel[:ACQuisition]:CURRent:CFACTOR 3
CHANnel[:ACQuisition]:CURRent:INVert 1

*****
// Query the settings:
CHANnel[:ACQuisition]:CURRent:RANGe:AUTO?
// Response: 0
CHANnel[:ACQuisition]:CURRent:RANGe?
// Response: 0.005
CHANnel[:ACQuisition]:CURRent:CFACTOR?
// Response: 3
CHANnel[:ACQuisition]:CURRent:INVert?
// Response: 1

*****
// Configure the peakhold function
*****
// activate peakhold and reset the value
// query the peakhold state

CHANnel[:ACQuisition]:PEAKhold:ACTivate 1
CHANnel[:ACQuisition]:PEAKhold:RESet
CHANnel[:ACQuisition]:PEAKhold:ACTivate?
// Respnse: 1

*****
// Configure the peakhold function
*****
// Query the overcurrent protection state.
// Reset the overcurrent protection state.

CHANnel[:ACQuisition]:CURRent:PROTection?
// Response: 1
CHANnel[:ACQuisition]:CURRent:PROTection:RESet
```

CHANnel[:ACQuisition]:CURRent:CFACTOR.....	192
CHANnel[:ACQuisition]:CURRent:INVert.....	192
CHANnel[:ACQuisition]:CURRent:PROTection:RESet.....	192
CHANnel[:ACQuisition]:CURRent:PROTection?.....	193
CHANnel[:ACQuisition]:CURRent:RANGe.....	193
CHANnel[:ACQuisition]:CURRent:RANGe:AUTO.....	193
CHANnel[:ACQuisition]:MODE.....	194
CHANnel[:ACQuisition]:MODE[:AC]:PLL.....	194
CHANnel[:ACQuisition]:MODE[:FILTer]:ANALog.....	194
CHANnel[:ACQuisition]:MODE[:FILTer]:DIGital.....	195
CHANnel[:ACQuisition]:MODE[:FILTer]:FREQuency.....	195
CHANnel[:ACQuisition]:PEAKhold:ACTivate.....	195
CHANnel[:ACQuisition]:PEAKhold:RESet.....	195
CHANnel[:ACQuisition]:VOLTage:CFACTOR.....	196
CHANnel[:ACQuisition]:VOLTage:INVert.....	196
CHANnel[:ACQuisition]:VOLTage:RANGe.....	196
CHANnel[:ACQuisition]:VOLTage:RANGe:AUTO.....	196

CHANnel[:ACQuisition]:CURRent:CFACTOR <CrestFactor>

Selects the crest factor for current measurement.

Parameters:

<CrestFactor> 1 | 3 | 6
 Value of the crest factor.

Example: See [Example"ACQuisition settings"](#) on page 189.

Manual operation: See ["CREST FACT"](#) on page 68

CHANnel[:ACQuisition]:CURRent:INVert <State>

Inverts the current measurement reading.

Parameters:

<State> 1 | 0 ON | OFF
 ON | 1
 Inverts the current value.
 OFF | 0
 Turns off the inversion of the current value.

Example: See [Example"ACQuisition settings"](#) on page 189.

Manual operation: See ["INVERT"](#) on page 68

CHANnel[:ACQuisition]:CURRent:PROTection:RESet

Resets the overcurrent protection state.

Example: See [Example"ACQuisition settings"](#) on page 189.

Usage: Event

CHANnel[:ACQuisition]:CURRent:PROTection?

Queries the overcurrent protection state.

Return values:

<PROTection> 1 | 0

1
The overcurrent protection has tripped.

0
The overcurrent protection has not tripped.

Example: See [Example"ACQuisition settings"](#) on page 189.

Usage: Query only

CHANnel[:ACQuisition]:CURRent:RANGe <RmsValue>

Selects the current range.

Setting the value manually deactivates the automatic measurement current range , set with command [CHANnel\[:ACQuisition\]:CURRent:RANGe:AUTO](#) on page 193.

Parameters:

<RmsValue> 0.0025 | 0.005 | 0.01 | 0.015 | 0.02 | 0.25 | 0.03 | 0.05 | 0.06 |
0.1 | 0.15 | 0.2 | 0.25 | 0.3 | 0.5 | 0.6 | 1 | 1.5 | 2 | 2.5 | 3 | 5 | 6 |
10 | 15 | 20 | 30 | 60

The available setting depends on the crest factor, selected with [CHANnel\[:ACQuisition\]:CURRent:CFACTOR](#).

See [Table 6-2](#).

Range: 0.0025 to 60

Default unit: A

Example: See [Example"ACQuisition settings"](#) on page 189.

Manual operation: See ["RANGE"](#) on page 67

CHANnel[:ACQuisition]:CURRent:RANGe:AUTO <State>

Activates the automatic current measurement range setting.

Parameters:

<State> 1 | 0 ON | OFF

ON | 1
Selects the current measurement range automatically.

OFF | 0
Turns off the automaitc current measurement range.

Example: See [Example"ACQuisition settings"](#) on page 189.

Manual operation: See ["AUTORANGE"](#) on page 67

CHANnel[:ACQuisition]:MODE <Mode>

Selects the acquisition mode.

Parameters:

<Mode> AC | DC | AUTO | EXTern

AC

Measures the average voltage or current AC (synchronization on period duration).

DC

Measures pure DC loads.

AUTO

Sels the acquisition mode automatically.

EXTern

Measures external signals.

Example: See [Example"ACQuisition settings"](#) on page 189.

Manual operation: See ["Mode"](#) on page 69

CHANnel[:ACQuisition]:MODE[:AC]:PLL <Ref_Value>

Selects the reference value of the synchronization frequency (Phase Locked Loop Source).

Parameters:

<Ref_Value> VOLTage | CURRent

VOLTage

Uses the voltage value as reference source.

CURRent

Uses the current value as reference source.

Example: See [Example"ACQuisition settings"](#) on page 189.

Manual operation: See ["PLL SRC"](#) on page 69

CHANnel[:ACQuisition]:MODE[:FILTer]:ANALog <State>

Activates the low-pass filter function.

Parameters:

<State> 1 | 0

ON | 1

Active lowpass filter function.

OFF | 0

Disabled lowpass filter function.

Example: See [Example"ACQuisition settings"](#) on page 189.

Manual operation: See ["BWL 1KHZ"](#) on page 70

CHANnel[:ACQuisition]:MODE[:FILTer]:DIGital <State>

Enables the digital filter function.

Parameters:

<State> 1 | 0 | ON | OFF
ON | 1
 Turns on the digital filter.
OFF | 0
 Turns off the digital filter.

Example: See [Example"ACQuisition settings"](#) on page 189.

Manual operation: See ["DIG. FILTER"](#) on page 70

CHANnel[:ACQuisition]:MODE[:FILTer]:FREQuency <State>

Enables the frequency filter function.

Parameters:

<State> 1 | 0 ON | OFF
ON | 1
 Activates the frequency filter.
OFF | 0
 Turns off the frequency filter.

Example: See [Example"ACQuisition settings"](#) on page 189.

Manual operation: See ["FREQ FILTER"](#) on page 69

CHANnel[:ACQuisition]:PEAKhold:ACTivate <State>

Activates the peak hold function.

Parameters:

<State> 1 | 0 | ON | OFF
 *RST: OFF | 0

Example: See [Example"ACQuisition settings"](#) on page 189.

Manual operation: See ["Activate"](#) on page 70

CHANnel[:ACQuisition]:PEAKhold:RESet

Resets the saved peak value.

To monitor maximum peak values, activate the peak hold function with command [CHANnel\[:ACQuisition\]:PEAKhold:ACTivate](#) on page 195.

Example: See [Example"ACQuisition settings"](#) on page 189.

Usage: Event

Manual operation: See ["Reset"](#) on page 71

CHANnel[:ACQuisition]:VOLTage:CFACTOR <CrestFactor>

Selects the crest factor for voltage measurement.

Parameters:

<CrestFactor> 1 | 3 | 6
Value of the crest factor.

Example: See [Example"ACQuisition settings"](#) on page 189.

Manual operation: See ["CREST FACT"](#) on page 66

CHANnel[:ACQuisition]:VOLTage:INVert <State>

Inverts the voltage measurement reading.

Parameters:

<State> 1 | 0 | ON | OFF
ON | 1
Inverts the voltage value.
OFF | 0
Turns off the inversion of the voltage value.

Example: See [Example"ACQuisition settings"](#) on page 189.

Manual operation: See ["INVERT"](#) on page 66

CHANnel[:ACQuisition]:VOLTage:RANGe <RmsValue>

Selects the voltage range.

Setting the value manually deactivates the automatic measurement voltage range, set with command [CHANnel\[:ACQuisition\]:VOLTage:RANGe:AUTO](#) on page 196.

Parameters:

<RmsValue> 2.5 | 5 | 7.5 | 15 | 30 | 45 | 60 | 75 | 150 | 300 | 450 | 600 | 900 | 1800
The available setting depends on the crest factor, selected with [CHANnel\[:ACQuisition\]:VOLTage:CFACTOR](#).
See [Table 6-1](#).
Range: 2.5 to 1800
Default unit: V

Example: See [Example"ACQuisition settings"](#) on page 189.

Manual operation: See ["RANGE"](#) on page 66

CHANnel[:ACQuisition]:VOLTage:RANGe:AUTO <State>

Enables the automatic voltage measurement range setting.

Parameters:

<State> 1 | 0 ON | OFF

ON | 1

Selects the voltage measurement range automatically.

OFF | 0

Turns off the automatic voltage measurement range.

*RST: ON | 1

Example: See [Example "ACQuisition settings"](#) on page 189.

Manual operation: See ["AUTORANGE"](#) on page 66

13.4 CHANnel:EXternal subsystem

The CHANnel:EXternal subsystem contains the commands for configuring the external interfaces.

Example: Input and output settings

The example represents the remote control commands for configuring the settings for measurements of input or output signals.

```

*****
// Configure an analog input signal
*****
// Configure the parameters:
// Assign the analog input value
// to the display, e.g. measurement page 2
// field 1
// activate the measurement
*****
VIEW:NUMeric:PAGE2:CELL1:FUNCTION AIN
CHANnel[:EXtern]:AINPut[:STATe] 1

*****
// Query the settings
VIEW:NUMeric:PAGE2:CELL1:FUNCTION?
// Response: AIN
CHANnel[:EXtern]:AINPut[:STATe]?
// Response: 1

*****
// Measuring an analog output signal
*****
// Configure the parameters:
// configure the measurement window,
// e.g. display voltage, current, power
// and limit parameters on page 3
// select the analog output mode
// activate analog signal output
*****
VIEW:NUMeric:PAGE3:SIZE 6
VIEW:NUMeric:PAGE3:CELL1:FUNCTION URMS
VIEW:NUMeric:PAGE3:CELL2:FUNCTION IRMS
VIEW:NUMeric:PAGE3:CELL3:FUNCTION P
VIEW:NUMeric:PAGE3:CELL4:FUNCTION S
VIEW:NUMeric:PAGE3:CELL5:FUNCTION LIM1
VIEW:NUMeric:PAGE3:CELL6:FUNCTION LIM2
CHANnel[:EXtern]:AOUTput:MODE VOLTage

// alternative current or power output modes
// CHANnel[:EXtern]:AOUTput:MODE CURRent
// CHANnel[:EXtern]:AOUTput:MODE POver
// additional settings for limit output mode
// CHANnel:LIMit2:SOURce URMS
// CHANnel:LIMit2:HIGH 60
// CHANnel:LIMit2:LOW 10

```

```

// CHANnel[:EXTerN]:AOUTput:MODE LIMit2
CHANnel[:EXTerN]:AOUTput[:STATe] 1

*****

// Query the settings
CHANnel[:EXTerN]:AOUTput:MODE?
// Response: VOLTage
CHANnel[:EXTerN]:AOUTput[:STATe]?
// Response: 1

*****

// Configure a digital input signal
*****
// Configure the parameters:
// Assign the digital input value
// to the display, e.g. measurement page 1
// field 1
// select the parameter to be measured
// invert the incoming signal
// activate the measurement
*****
VIEW:NUMeric:PAGE1:CELL1:FUNCTION DIN
CHANnel[:EXTerN]:DINput:MODE STATe
CHANnel[:EXTerN]:DINPut:INVert 1
CHANnel[:EXTerN]:DINPut[:STATe] 1

*****

// Query the settings
VIEW:NUMeric:PAGE1:CELL1:FUNCTION?
// Response: DIN
CHANnel[:EXTerN]:DINput:MODE?
// Response: STATe
CHANnel[:EXTerN]:DINPut:INVert?
// Response: 1
CHANnel[:EXTerN]:DINPut[:STATe]?
// Response: 1

*****

// Configure a digital output signal
*****
// Configure the parameters:
// configure the measurement window,
// e.g. display voltage, current, frequency
// and limit parameters on page 4
// select the digital output mode

// activate digital signal output
*****
VIEW:NUMeric:PAGE4:SIZE 6

```

```
VIEW:NUMeric:PAGE4:CELL1:FUNCTion URMS
VIEW:NUMeric:PAGE4:CELL2:FUNCTion IRMS
VIEW:NUMeric:PAGE4:CELL3:FUNCTion FU
VIEW:NUMeric:PAGE4:CELL4:FUNCTion FPLL
VIEW:NUMeric:PAGE4:CELL5:FUNCTion LIM1
VIEW:NUMeric:PAGE4:CELL6:FUNCTion LIM2
CHANnel:LIMit2:SOURce URMS
CHANnel:LIMit2:HIGH 60
CHANnel:LIMit2:LOW 10
// CHANnel[:EXTErn]:DOUtput:MODE LIMit2
CHANnel[:EXTErn]:DOUtput:MODE LIMit
// alternative output mode
// CHANnel[:EXTErn]:DOUtput:MODE FPLL

CHANnel[:EXTErn]:DOUtput[:STATe] 1

*****
// Query the settings
CHANnel[:EXTErn]:DOUtput:MODE?
// Response: LIMit
CHANnel[:EXTErn]:DOUtput[:STATe]?
// Response: 1
```

Example: SENsor settings

The example represents the remote control commands for configuring the settings for measurements with external probes.

```

*****
// Configure a voltage based measurement
// with an external shunt
*****
// Configure the parameters:
// set the measurement mode for the external shunt
// set the voltage range to 100 mV
// and the resistance to 1 Ohm
// start the measurement
*****
CHANnel[:EXTErn]:SENSor:MODE EXTShunt
CHANnel[:EXTErn]:SENSor:EXTShunt[:RESistance] 1
CHANnel[:EXTErn]:SENSor:RANGe 0.1
CHANnel[:EXTErn]:SENSor[:STATe] 1

*****
// Query the settings
CHANnel[:EXTErn]:SENSor:MODE?
// Response: EXTShunt
CHANnel[:EXTErn]:SENSor:EXTShunt[:RESistance]?
// Response: 1
CHANnel[:EXTErn]:SENSor:RANGe?
// Response: 0.1
CHANnel[:EXTErn]:SENSor[:STATe]?
// Response: 1

*****
// Configure a current based measurement
// with an external clamp-on probe
*****
// Configure the parameters:
// set the measurement mode for the current probe
// set the voltage range to 1 V
// and the current to voltage ratio to 10 mVA
// start the measurement
*****
CHANnel[:EXTErn]:SENSor:MODE CCLamp
CHANnel[:EXTErn]:SENSor:CCLamp[:RATIo] 0.01
CHANnel[:EXTErn]:SENSor:RANGe 1
CHANnel[:EXTErn]:SENSor[:STATe] 1

*****
// Query the settings
CHANnel[:EXTErn]:SENSor:MODE?
// Response: CCLamp

```

```

CHANnel[:EXTErn]:SENSor:CCLamp[:RATio]?
// Response: 0.01
CHANnel[:EXTErn]:SENSor:RANGe?
// Response: 1
CHANnel[:EXTErn]:SENSor[:STATe]?
// Response: 1

```

CHANnel[:EXTErn]:AINPut[:STATe].....	202
CHANnel[:EXTErn]:AOUTput:MODE.....	202
CHANnel[:EXTErn]:AOUTput[:STATe].....	203
CHANnel[:EXTErn]:DINPut:INVert.....	203
CHANnel[:EXTErn]:DINput:MODE.....	203
CHANnel[:EXTErn]:DINPut[:STATe].....	204
CHANnel[:EXTErn]:DOUTput:INVert.....	204
CHANnel[:EXTErn]:DOUTput:MODE.....	204
CHANnel[:EXTErn]:DOUTput[:STATe].....	204
CHANnel[:EXTErn]:SENSor[:STATe].....	205
CHANnel[:EXTErn]:SENSor:CCLamp[:RATio].....	205
CHANnel[:EXTErn]:SENSor:EXTShunt[:RESistance].....	205
CHANnel[:EXTErn]:SENSor:MODE.....	205
CHANnel[:EXTErn]:SENSor:RANGe.....	206

CHANnel[:EXTErn]:AINPut[:STATe] <State>

Activates the measurement of an externally supplied analog signal.

Parameters:

<State> 1 | 0 | (ON | OFF)

Example: See [Example "Input and output settings"](#) on page 198.

Manual operation: See ["ACTIVATE"](#) on page 129
See ["MODE"](#) on page 129

CHANnel[:EXTErn]:AOUTput:MODE <Mode>

Selects the external mode for the analog output signal.

Parameters:

<Mode> LIMit<n> | VOLTage | CURRent | POWer

VOLTage

Selects the voltage of the output signal standardized to +-5V of the input signal.

CURRent

Selects the current of the output signal standardized to +-5V of the input signal.

POWer

Selects the power of the output signal standardized to +-5V of the instantaneous power.

LIMit<n>

Selects the parameter with an assigned limit, selected with command `CHANnel:LIMit<n>:SOURce` on page 209. The suffix <n> selects the position of the parameter in the limit list.

Example: See [Example "Input and output settings"](#) on page 198.

CHANnel[:EXTErn]:AOUTput[:STATe] <State>

Activates the analog signal output.

Parameters:

<State> 1 | 0 | (ON | OFF)

Example: See [Example "Input and output settings"](#) on page 198.

Manual operation: See ["MODE"](#) on page 129

CHANnel[:EXTErn]:DINPut:INVert <State>

Inverts the digital input signal.

Parameters:

<State> 1 | 0 ON | OFF

ON | 1

Inverts the signal.

OFF | 0

Turns off the inversion.

Example: See [Example "Input and output settings"](#) on page 198.

Manual operation: See ["INVERT \(Digital In\)"](#) on page 132

CHANnel[:EXTErn]:DINput:MODE <Mode>

Selects the measurement parameter of the digital input signal.

Parameters:

<Mode> FREQuency | PWM | STATe

FREQuency

Measures the frequency.

PWM

Acquires the ratio of the high to low times.

STATe

Measures the high and low levels.

Example: See [Example "Input and output settings"](#) on page 198.

Manual operation: See ["MODE \(Digital In\)"](#) on page 131

CHANnel[:EXTErn]:DINPut[:STATe] <State>

Activates the measurement of an externally supplied digital signal.

Parameters:

<State> 1 | 0 | (ON | OFF)

Example: See [Example "Input and output settings"](#) on page 198.

Manual operation: See ["ACTIVATE"](#) on page 131

CHANnel[:EXTErn]:DOUtpuT:INVert <State>

Inverts the digital output signal.

Parameters:

<State> 1 | 0 ON | OFF

ON | 1

Inverts the signal.

OFF | 0

Turns off the inversion.

Example: See [Example "Input and output settings"](#) on page 198.

Manual operation: See ["INVERT \(Digital Out\)"](#) on page 132

CHANnel[:EXTErn]:DOUtpuT:MODE <Mode>

Selects the parameter for the digital output.

Parameters:

<Mode> LIMIT<n> | FPLL

LIMit<n>

Provides limit readings of parameter, selected with command [CHANnel:LIMit<n>:SOURce](#) on page 209. The suffix <n> selects the position of the parameter in the limit list.

FPLL

Provides the frequency of the selected parameter.

Example: See [Example "Input and output settings"](#) on page 198.

Manual operation: See ["MODE \(Digital Out\)"](#) on page 132

CHANnel[:EXTErn]:DOUtpuT[:STATe] <State>

Activates the digital signal output.

Parameters:

<State> 1 | 0 | (ON | OFF)

Example: See [Example "Input and output settings"](#) on page 198.

Manual operation: See ["ACTIVATE"](#) on page 131

CHANnel[:EXTErn]:SENSor[:STATE] <State>

Activates the measurement with an external probe.

Enabled sensor measurement disables automatic current measurement.

Parameters:

<State> 1 | 0 | (ON | OFF)

Example: See [Example"SENsor settings"](#) on page 201.

Manual operation: See ["ACTIVATE"](#) on page 133

CHANnel[:EXTErn]:SENSor:CCLamp[:RATIo] <Value>

Sets the ratio of current to voltage for measurements with current probes. To select the corresponding mode set [CHANnel\[:EXTErn\]:SENSor:MODE > CCLamp](#).

Parameters:

<Value> MIN | MAX | DEV
Range: 0.001 to 1
Default unit: VA

Example: See [Example"SENsor settings"](#) on page 201.

Manual operation: See ["RATIO"](#) on page 134
See ["USER"](#) on page 134

CHANnel[:EXTErn]:SENSor:EXTShunt[:RESistance] <Value>

Sets the resistance of the external shunt. To select the corresponding mode set [CHANnel\[:EXTErn\]:SENSor:MODE >EXTShunt](#).

Parameters:

<Value> MIN | MAX | DEV
Range: 0.999 to 1
Default unit: Ω

Example: See [Example"SENsor settings"](#) on page 201.

Manual operation: See ["RESISTANCE"](#) on page 134

CHANnel[:EXTErn]:SENSor:MODE <Mode>

Selects the measurement mode according to the external probe.

Parameters:

<Mode> EXTShunt | CCLamp

Example: See [Example"SENsor settings"](#) on page 201.

Manual operation: See ["MODE"](#) on page 134

CHANnel[:EXTErn]:SENSor:RANGe <Voltage_peak>

Selects the voltage measurement range.

Parameters:

<Voltage_peak> 0.1 | 1 | 4

Default unit: V

Example: See [Example "SENSOR settings"](#) on page 201.

Manual operation: See ["RANGE"](#) on page 133

13.5 CHANnel:LIMit subsystem

The subsystem contains the commands for configuring limit values for measurement parameters.

Example: LIMit settings

The example represents the remote control commands for configuring the measurement limits.

```
*****
// Configure the parameters:
// e.g. select 3 parameters, e.g. active power P
// root mean square voltage Urms and phase shift PHI
// set the minimum and maximum values
// activate limitation
// *****
```

```
CHANnel:LIMit1:SOURce P
CHANnel:LIMit1:HIGh 1
CHANnel:LIMit1:LOW 0.5
CHANnel:LIMit2:SOURce URMS
CHANnel:LIMit2:HIGh 60
CHANnel:LIMit2:LOW 10
CHANnel:LIMit3:SOURce PHI
CHANnel:LIMit3:HIGh 4.8
CHANnel:LIMit3:LOW -0.2
CHANnel:LIMit1:STATe 1
CHANnel:LIMit2:STATe 1
CHANnel:LIMit3:STATe 1
```

```
*****
// Query the settings
CHANnel:LIMit1:SOURce?
// Response: P
CHANnel:LIMit1:HIGh?
// Response: 1
CHANnel:LIMit1:LOW?
// Response: 0.5
CHANnel:LIMit2:SOURce?
// Response: URMS
// ....
```

```
*****
// Query limit progress and result

CHANnel:LIMit1:RESult[:STATe]?
// Response: 1
CHANnel:LIMit1:PERCent?
// Response: 35
```

CHANnel:LIMit<n>:HIGh.....	208
CHANnel:LIMit<n>:LOW.....	208
CHANnel:LIMit<n>:PERCent?.....	208

CHANnel:LIMit<n>RESult[:STATe].....	209
CHANnel:LIMit<n>:SOURce.....	209
CHANnel:LIMit<n>[:STATe].....	209

CHANnel:LIMit<n>:HIGH <Value>

Sets the maximum value for the selected parameter.

The cell index determines the position of the parameter in the list of limits.

Suffix:

<n> 1 to 6
Selects the position of the limited parameter.

Parameters:

<Value> numeric
Range: depends on parameter
Default unit: depends on parameter

Example: See [Example"LIMit settings"](#) on page 207.

Manual operation: See ["HIGH"](#) on page 94

CHANnel:LIMit<n>:LOW <Value>

Sets the minimum value for the selected parameter.

The cell index determines the position of the parameter in the list of limits.

Suffix:

<n> 1 to 6
Selects the position of the limited parameter.

Parameters:

<Value> numeric
Range: depends on parameter
Default unit: depends on parameter

Example: See [Example"LIMit settings"](#) on page 207.

Manual operation: See ["LOW"](#) on page 94

CHANnel:LIMit<n>:PERCent? <Value>

Queries the result of limit calculation between min and max values

Parameters:

<State> numeric
Default unit: %

Example: See [Example"LIMit settings"](#) on page 207.

Usage: Query only

CHANnel:LIMit<n>RESult[:STATe] <State>

Queries the result of the limit check.

Parameters:

<State> 1 | 0 | ON | OFF

Example: See [Example "LIMit settings"](#) on page 207.

CHANnel:LIMit<n>:SOURce <Name>

Selects the measurement parameter for configuring the limits.

The cell index determines the position of the parameter in the list of limits.

Suffix:

<n> 1 to 6
Selects the position of the limited parameter.

Parameters:

<Name> EMPTY | FI | FPLL | FU | IAVG | IRMS | ITHD | LAMBda | P |
PHI | Q | S | UAVG | URMS | UTHD

See [Table 7-1](#) for the list of parameters.

Example: See [Example "LIMit settings"](#) on page 207.

Manual operation: See ["SOURCE"](#) on page 94

CHANnel:LIMit<n>[:STATe] <State>

Activates the limit function for the selected parameter.

Parameters:

<State> 1 | 0 | ON | OFF

Example: See [Example "LIMit settings"](#) on page 207.

Manual operation: See ["ACTIVATE"](#) on page 94

13.6 CHANnel:MEASurement subsystem

The CHANnel:MEASurement subsystem contains the commands for configuring the external interfaces.

Example: MEASurement settings

The example represents the remote control commands for configuring the settings for measurements with external probes.

```
*****
// Set the format of the measurement value.
// Define the measurement function list.
*****
CHANnel:MEASurement:FORMat BIN
CHAN:MEAS:FUNctions P,S,Q,LAMB,PHI

*****
// Query the readings and settings:
// measurement value of all activated cells
// measurement function list
// number of defined functions

CHANnel:MEASurement:DATA?
// Response: 0.0114444,5.12711E-05,-2.34079E-07,NAN,5,0.005,NAN
CHANnel:MEASurement:FORMat?
// Response: BIN
CHANnel:MEASurement:FUNctions?
// Response: P,S,Q,LAMB,PHI
CHANnel:MEASurement:FUNctions? 3
// Response: Q
CHANnel:MEASurement:FUNctions:COUNT?
//Response: 5

*****
// Query the voltage and current values
// measured in inrush and waveform views

CHANnel:MEASurement:INRush:CURRent[:DATA]?
// Response: -5.49333e-05,-4.39467e-05,-5.67644e-05,...
CHANnel:MEASurement:INRush:VOLTage[:DATA]?
// Response: 6.48213,6.20746, 6.15253,...
CHANnel:MEASurement:WAVEform:CURRent[:DATA]?
// Response: -5.49333e-05,-4.39467e-05,-5.67644e-05,...
CHANnel:MEASurement:WAVEform:VOLTage[:DATA]?
// Response: 6.48213,6.20746, 6.15253,...
```

CHANnel:MEASurement:DATA?	211
CHANnel:MEASurement:FORMat	211
CHANnel:MEASurement:FUNctions	211
CHANnel:MEASurement:FUNctions:COUNT??	212
CHANnel:MEASurement:INRush:CURRent[:DATA]??	212

CHANnel:MEASurement:INRush:VOLTage[:DATA]??.....	212
CHANnel:MEASurement:WAVeform:CURRent[:DATA]??.....	212
CHANnel:MEASurement:WAVeform:VOLTage[:DATA]??.....	213

CHANnel:MEASurement:DATA? [<Cell>]

Queries the measurement value of all or a single measurements cell.

Query parameters:

[<Cell>] Selects the measurement cell.
 1 to 6 or 1 to 10, depending on the selected page size, see
[VIEW:NUMeric:PAGE<n>:SIZE](#) on page 243.

Return values:

<Data> Comma-separated list of values.
 If "NAN" is displayed (measurement format = ASCII), either the
 measurement cell was empty (EMPTY) or the measured value
 could not be displayed due to the chosen settings.

Example: See [Example"MEASurement settings"](#) on page 210.

Usage: Query only

CHANnel:MEASurement:FORMat <Format>

Sets the data format for querying the measured values.

Parameters:

<Format> BINary | ASCii
BINary
 Binary format (4 bytes IEEE float)
ASCii
 ASCII format

Example: See [Example"MEASurement settings"](#) on page 210.

CHANnel:MEASurement:FUNCTions <Function>{,<Function>}

CHANnel:MEASurement:FUNCTions? [<Index>]

Sets the list of measurement function names for [CHANnel:MEASurement:DATA?](#)
 on page 211. The measurement function list is independent from the displayed mea-
 surement cells.

Parameters:

<Function> Available functions are listed in [VIEW:NUMeric:PAGE<n>:](#)
 {,<Function>} [CELL<m>:FUNCTion](#) on page 243.

Query parameters:

[<Index>] Selects the measurement index.
 Range: 1 to 6 or 1 to 10, depending on the selected page
 size.

Example: See [Example"MEASurement settings"](#) on page 210.

CHANnel:MEASurement:FUNCtions:COUNT??

Queries the number of measurement functions which are defined with the command [CHANnel:MEASurement:FUNCtions](#) on page 211.

Return values:

<Count> Range: 1 to 250

Example: See [Example"MEASurement settings"](#) on page 210.

Usage: Query only

CHANnel:MEASurement:INRush:CURRENT[:DATA]?? <Value>

Queries the values of the current trace in the inrush view.

To set the output format, use the command [CHANnel:MEASurement:FORMat](#) on page 211.

Parameters:

<value>

Example: See [Example"View settings"](#) on page 237.

Usage: Query only

CHANnel:MEASurement:INRush:VOLTage[:DATA]?? <Value>

Queries the values of the voltage trace in inrush view.

To set the output format, use the command [CHANnel:MEASurement:FORMat](#) on page 211.

Parameters:

<value>

Example: See [Example"View settings"](#) on page 237.

Usage: Query only

CHANnel:MEASurement:WAVEform:CURRENT[:DATA]?? <Value>

Queries the values of the current trace in the waveform view.

To set the output format, use the command [CHANnel:MEASurement:FORMat](#) on page 211.

Parameters:

<value>

Example: See [Example"View settings"](#) on page 237.

Usage: Query only

CHANnel:MEASurement:WAVeform:VOLTage[:DATA]?? <Value>

Queries the values of the voltage trace in the waveform view.

To set the output format, use the command `CHANnel:MEASurement:FORMat` on page 211.

Parameters:

<value>

Example: See [Example "View settings"](#) on page 237.

Usage: Query only

13.7 CHANnel:NAME subsystem

The `CHANnel:NAME` subsystem contains the commands for configuring the .

Example: NAME settings

The example represents the remote control commands for configuring the .

```
*****
// Define the channel name.
*****
CHANnel:NAME 'channel5'

*****
// Query the channel name
CHANnel:NAME?
// Response: 'channel5'
```

[CHANnel:NAME](#)..... 213

CHANnel:NAME <String>

Defines or queries the channel name.

Parameters:

<String> String with up to 8 characters.

Example: See [Example "NAME settings"](#) on page 213.

13.8 DATA subsystem

The `DATA` subsystem contains the commands for .

Example: DATA settings

The example represents the remote control commands for .

```
*****
// Return the logging data values of the selected storage location and file name.
// Delete the logging file data values of the selected storage location and file name.

*****
DATA:DATA? 'LOG0001.CSV',EXT
// Response: URMS[V];IRMS[A];P[W];FU[Hz];EMPTY;EMPTY;S[VA];Q[var]; LAMBDA[]
;UTHD[%];Timestamp
231.27E+00;45.0E-03;6.63E+00;50.0E+00;10.38E+00; 7.98E+00
DATA:DEL 'LOG0001.CSV',EXT

*****
// Query all saved logging files of the selected storage location.
DATA:LIST? EXT
// Response: 'LOG0001.CSV', 'LOG0002.CSV', 'LOG0003.CSV'
// Query the number of log file values of the selected storage location and file name.
DATA:POIN? 'LOG0001.CSV',EXT
// Response: 5
```

DATA:DATA?.....	214
DATA:DELeTe.....	215
DATA:LIST?.....	215
DATA:POINts?.....	215

DATA:DATA? <Filename>,[<Location>]

Returns the logging file data values of the selected storage location and file name. If no logging file is found, the message „No Logging Files found“ is displayed. If no storage location is selected, the instrument queries the internal memory. Please notice that the logging function has to be activated, if you want to use the manual trigger mode (trigger via TRIG button). Without activating the logging function in manual trigger mode, the instrument is not able to save a logging file internally or on the USB stick.

Return values:

<Filename>	String parameter to specify the name and directory of the logging file.
[<Location>]	INT Internal memory
	EXT USB stick

Example: Filename: "LOG0029.CSV"
 External logging file (USB stick), count = 3
 DATA:DATA? 'LOG0001.CSV' ",EXT
 URMS[V];IRMS[A];P[W];FU[Hz];EMPTY;EMPTY;S[VA];Q[var]; LAMBDA[]
 ;UTHD[%];Timestamp
 231.27E+00;45.0E-03;6.63E+00;50.0E+00;10.38E+00; 7.98E+00
 231.38E+00;45.0E-03;6.64E+00;50.0E+00;+00;7.98E+00; 639E-03
 231.35E+00;45.0E-03;6.63E+00;50.0E+00;10.38E+00; 7.98E+00

Example: See [Example"DATA settings"](#) on page 214.

Usage: Query only

DATA:DELeTe <Filename>,[<Location>]

Deletes the logging file data values of the selected storage location and file name. If no storage location is selected, the instrument uses the internal memory.

Parameters:

<Filename> String parameter to specify the name and directory of the logging file.

<Location> INT | EXT

INT
Internal memory

EXT
USB stick

Example: See [Example"DATA settings"](#) on page 214.

DATA:LIST? [<Location>]

Queries all saved logging files of the selected storage location. If no storage location is selected, the instrument queries the internal memory. If you store the logging file on the USB stick, the query returns all files.

Parameters:

[<Location>] INT | EXT

INT
Internal memory

EXT
USB stick

Example: See [Example"DATA settings"](#) on page 214.

Usage: Query only

DATA:POINts? <Filename>,[<Location>]

Queries the number of log file values of the selected storage location and file name. If no storage location is selected, the instrument queries the internal memory.

Query parameters:

<Filename> String parameter to specify the name and directory of the logging file.

[<Location>] INT | EXT

Return values:

<Count> Number of log file values, depending on the log file.

Example: External logging file (USB stick), count = 5
 DATA:POIN? 'LOG0001.CSV',EXT
 <-- 5

Example: See [Example"DATA settings"](#) on page 214.

Usage: Query only

13.9 DISPlay subsystem

The DISPlay subsystem contains the commands for configuring the .

Example: DISPlay settings

The example represents the remote control commands for configuring .

```
// *****
// Display a text message box on the front display.
// Clear the text message box on the front display.
// Turn on the screen backlight
// *****
DISPlay:TEXT 'NPA101'
// Response: 'NPA101' shown on the front display
DISPlay:TEXT:CLEAr
DISPlay:STATe 1
```

DISPlay[::STATe]	216
DISPlay:TEXT:CLEAr	216
DISPlay:TEXT[::DATA]	217

DISPlay[::STATe] <String>

Activates the backlight of the screen.

Parameters:

<State> 1 | 0 | ON | OFF

Example: See [Example"DISPlay settings"](#) on page 216.

DISPlay:TEXT:CLEAr

Clears the text message box on the front display.

Example: See [Example"DISPlay settings"](#) on page 216.

Usage: Setting only

DISPlay:TEXT[:DATA] <String>

Displays a text message box on the front display.

Example: See [Example"DISPlay settings"](#) on page 216.

13.10 HardCOPY Subsystem

The HardCOPY subsystem contains the commands for configuring hardcopies.

Example: HardCOPY settings

The example represents the remote control commands for prints of the screen.

```
*****
// Select the data format for the screenshot.
*****
HCOPY: FORMat PNG

*****
// Query the screenshot parameters
HCOPY FORMat?
// Response: PNG
HCOPY:SIZE:X?
// Response: 320
HCOPY:SIZE:Y?
// Response: 240
HCOPY:DATA?
// Response: screenshot data in binary format
```

HCOPY:DATA?	217
HCOPY:FORMat	218
HCOPY:SIZE:X?	218
HCOPY:SIZE:Y?	218

HCOPY:DATA?

Returns the current display content (screenshot data) in binary format.

Example: See [Example"HardCOPY settings"](#) on page 217.

Usage: Query only

Manual operation: See ["SAVE"](#) on page 144

HCOPY:FORMat <Format>

Selects or queries the data format of the screenshot.

Parameters:

<Format> BMP | PNG
BMP
Windows Bitmap Format
PNG
Portable Network Graphic
*RST: BMP

Example: See [Example"HardCOPY settings"](#) on page 217.

Manual operation: See ["FORMAT"](#) on page 144

HCOPY:SIZE:X?

Returns the horizontal dimension of the screenshots.

Example: See [Example"HardCOPY settings"](#) on page 217.

Usage: Query only

Manual operation: See ["SAVE"](#) on page 144

HCOPY:SIZE:Y?

Returns the vertical dimension of the screenshots.

Example: See [Example"HardCOPY settings"](#) on page 217.

Usage: Query only

Manual operation: See ["SAVE"](#) on page 144

13.11 INTEgrator subsystem

The INTEgrator subsystem contains the commands for setting up the integrator mode.

Example: Integrator settings

The example represents the remote control commands for configuring the integrator mode.

```
*****
// Integrator measurements

*****
// Manual mode
*****
// Activate manual integrator mode
// start and stop measurement
// reset the integrator values
INTEgrator:MODE MAN
INTEgrator[:STATe] ON
INTEgrator:START
INTEgrator:STOP
INTEgrator:RESet

*****
// Query the settings
INTEgrator:MODE?
// Response: MAN
INTEgrator[:STATe]?
// Response: 1

*****
// Span mode
*****
INTEgrator:MODE SPAN
INTEgrator[:STATe] ON
INTEgrator:STIME 2020,5,1,13,30,00
INTEgrator:DURATION 150

*****
// Query the settings
INT?
// Response: 1
INTEgrator:MODE?
// Response: SPAN
INTEgrator:STIME?
// Response: 2020,5,1,13,30,00 // 2020-05-01, 13:30 pm
INTEgrator:DURATION?
// Response: 150 // 2 h 30 min,0 s

*****
// Duration mode
*****
INTEgrator[:STATe] ON
INTEgrator:MODE DURATION
```

```

INTEgrator:DUration 150

*****
// Query the settings
INT?
// Response: 1
INTEgrator:MODe?
// Response: 'DUR'
INTEgrator:DUration?
// Response: 150 // 2 h 30 min,0 s

*****
// External mode
*****
INTEgrator[:STATe] ON
INTEgrator:MODe EXtErnal
INTEgrator:RESet

*****
// Query the settings
INT?
// Response: 1
INTEgrator:MODe?
// Response: 'EXT'

```

INTEgrator:DUration	220
INTEgrator:MODe	221
INTEgrator:RESet	221
INTEgrator:STARt	221
INTEgrator:STIME	222
INTEgrator:STOP	222
INTEgrator[:STATe]	222

INTEgrator:DUration <Duration>

Sets the time interval of the integrator function for the span and duration mode. To set the mode, use the command [INTEgrator:MODe](#) on page 221.

Parameters:

<Duration> integer
 Numeric value in seconds.
 Range: 0 to 349199 (96 h)
 Default unit: s

Example: See [Example"Integrator settings"](#) on page 219.

Manual operation: See ["Duration"](#) on page 80

INTEgrator:MODE <Mode>

Selects the integrator mode.

Parameters:

<Mode>

MANual | DURation | SPAN | EXTernal

MANual

Selects manual triggering of the integrator measurement.

To start and stop the measurement, use the commands

[INTEgrator:START](#) on page 221 and [INTEgrator:STOP](#) on page 222.

DURation

Selects a defined time interval for the integrator measurement.

The measurement starts automatically when [INTEgrator\[:STATE\]= 1](#).

To set the time interval, use command [INTEgrator:DURation](#) on page 220.

SPAN

Selects a defined start time and time interval for the integrator measurement.

To set the start time and duration, use the commands

[INTEgrator:START](#) on page 221 and [INTEgrator:DURation](#) on page 220.

EXTernal

Enables an external trigger signal for the integrator measurement.

Example: See [Example"Integrator settings"](#) on page 219.

Manual operation: See ["Mode"](#) on page 78

INTEgrator:RESet

Resets the integration time.

Example: See [Example"Integrator settings"](#) on page 219.

Usage: Event

Manual operation: See ["Reset"](#) on page 79

INTEgrator:STARt

Starts the manual integrator mode, if the integration functionality is activated with the command [:INTEgrator:STATE 1](#).

Example: See [Example"Integrator settings"](#) on page 219.

Usage: Event

Manual operation: See ["Start Stop"](#) on page 79

INTEgrator:STIME <Year>,<Month>,<Day>,<Hour>,<Minute>,<Second>

Sets the integration start time.

Parameters:

<Year>	integer
<Month>	integer Range: 1 to 12
<Day>	integer Range: 1 to 365
<Hour>	integer Range: 0 to 23 Default unit: h
<Minute>	integer Range: 0 to 59 Default unit: min
<Second>	integer Range: 0 to 59 Default unit: s

Example: See [Example"Integrator settings"](#) on page 219.

Usage: SCPI confirmed

Manual operation: See ["Start Time"](#) on page 79
See ["Set to curr. time"](#) on page 79
See ["Set Date & Time"](#) on page 80

INTEgrator:STOP

Stops the manual integrator mode, when the integration functionality is running.

Set `:INTEgrator:STATe 1` and `:INTEgrator:START 1` to activate and start the measurement.

Example: See [Example"Integrator settings"](#) on page 219.

Usage: Event

Manual operation: See ["Start Stop"](#) on page 79

INTEgrator[:STATe] <State>

Activates the integrator functionality.

Parameters:

<State> 1 | 0 | ON | OFF

Example: See [Example"Integrator settings"](#) on page 219.

Manual operation: See ["Activate"](#) on page 78

13.12 LOG subsystem

The LOG subsystem contains the commands for setting the parameters of the data logging function.

Example: Logging data settings

The example represents the remote control commands for configuring the logging mode.

```
*****
// Configure the data logging function.
// Deactivate logging mode to set the parameters:
// Select or create a log file: enter the filename and storage location,
// e.g. an external USB stick.
*****
LOG:STATe OFF
LOG:FNAME "LogTest01.csv",EXT

*****
// Select the measurement data page
LOG:PAGE 2

*****
// Configure the parameters:
// select 10 min time interval, SPAN mode, start time and duration.
LOG:INTerval 300
LOG:MODE SPAN
LOG:STIME 2020,5,1,13,30,00
LOG:DURation 150

// :LOG:MODE COUNT
// :LOG:COUNT 100

*****
// Query the data logging settings
LOG:PAGE?
// Response: 2
LOG:FNAME?
// Response: 'LogTest01.CSV',EXT

LOG:INTerval?
/// Response 300
LOG:MODE?
// Response: SPAN
LOG:STIME?
// Response: 2020,5,1,13,30,00 // 2020-05-01, 13:30 pm
LOG:DURation?
// Response: 150 // 2 h 30 min,0 s
LOG:COUNT?
// Response: 100

*****
// Start and stop logging data
LOG[:STATe] ON
LOG[:STATe]?
```



```
// Response: 1 // logging data is activated
LOG:START
LOG:STOP
```

LOG:COUNT.....	225
LOG:DURation.....	225
LOG:FNAME.....	225
LOG:INTerval.....	226
LOG:MODE.....	226
LOG:PAGE.....	226
LOG:STIMe.....	227
LOG[:STATe].....	227

LOG:COUNT <Measurements>

Sets the number of measurement readings in count mode. To set the mode, use the command `LOG:MODE` on page 226 to be captured.

Parameters:

<Measurements> integer
 Range: 1 to 100000000

Example: See [Example"Logging data settings"](#) on page 224.

Manual operation: See ["COUNT"](#) on page 87

LOG:DURation <Log_Duration>

Defines the duration of logging for the measurement in span and duration mode. To set the mode, use the command `LOG:MODE` on page 226.

Parameters:

<Log_Duration> integer
 Numeric value in seconds.
 Range: 0 to 349199 (96h)

Example: See [Example"Logging data settings"](#) on page 224.

Manual operation: See ["Duration"](#) on page 87

LOG:FNAME <FileName>,[<Location>]

Sets the file name and path for the storing the data recorded during data logging.

The query returns the file name and path. You can query the information also when data logging is running.

Parameters:

<FileName> String with the filename.
 [<Location>] INT | EXT

INT

Internal memory

EXT

USB stick

Example: See [Example"Logging data settings"](#) on page 224.**LOG:INTerval** <Interval>

Selects the logging measurement interval. The measurement interval describes the time between the recorded measurements.

Parameters:

<Interval> Numeric value seconds, assignable in rounded steps:
 0.1|1|5|10|60|300|600
 Range: 0.1 to 600
 Default unit: s

Example: See [Example"Logging data settings"](#) on page 224.**Manual operation:** See ["INTERVAL"](#) on page 86**LOG:MODE** <Log_Mode>

Selects the data logging mode.

Parameters:

<Log_Mode> UNLlimited | COUNT | DURation | SPAN

UNLlimited
 No specified limit of measurement readings.

COUNT
 Determines the number of measurement readings.

DURation
 Sets a time interval between the measurement readings.

SPAN
 Defines start time and time span for the measurement readings.

*RST: UNL

Example: See [Example"Logging data settings"](#) on page 224.**Manual operation:** See ["MODE"](#) on page 86**LOG:PAGE** <Page>

Selects the measurement page index to be logged.

Parameters:

<Page> integer
 Range: 1 to 4

Example: See [Example"Logging data settings"](#) on page 224.

Manual operation: See ["LOG PAGE"](#) on page 86

LOG:STIME <Year>,<Month>,<Day>,<Hour>,<Minute>,<Second>

Sets the logging start time.

Parameters:

<Year>	integer
	Four-digit number, including the century and millenium information.
<Month>	Range: 1 to 12
<Day>	Range: 1 to 365
<Hour>	Range: 0 to 23 Default unit: h
<Minute>	Range: 0 to 59 Default unit: min
<Second>	Range: 0 to 59 Default unit: s

Example: See [Example"Logging data settings"](#) on page 224.

Usage: SCPI confirmed

Manual operation: See ["Start Time"](#) on page 87
See ["Set to curr. time"](#) on page 87
See ["Set Date & Time"](#) on page 88

LOG[:STATE] <State>

Activates the data logging function.

Parameters:

<State>	ON OFF 1 0
*RST:	OFF 0

Example: See [Example"Logging data settings"](#) on page 224.

Manual operation: See ["ACTIVATE"](#) on page 86

13.13 STATus subsystem

This system contains the commands for the status reporting system. See also [Chapter 12.1.4, "Status reporting system"](#), on page 167 for detailed information. *RST has no effect on the status registers.

13.13.1 Status operation register

This system contains the commands for controlling the `STATus:OPERation` register of the status reporting system.

The configuration commands set the corresponding register. They determine which status changes of the R&S NPA cause changes in the status registers.

Value range: Decimal values in the range 0 to 32767 ($=2^{15}-1$)

<code>STATus:OPERation:CONDition?</code>	228
<code>STATus:OPERation:ENABle</code>	228
<code>STATus:OPERation:NTRansition</code>	228
<code>STATus:OPERation:PTRansition</code>	228
<code>STATus:OPERation[:EVENT]?</code>	229

STATus:OPERation:CONDition?

Queries the CONDition part of the operational status register.

Return values:

<CONDition> Condition bits in decimal representation.

Range: 1 to 65535

Usage: Query only

STATus:OPERation:ENABle <Enable_value>

Enables or queries the bits in the enable register for the Standard Operation Register group.

Parameters:

<Enable_Value> Range: 1 to 65535

STATus:OPERation:NTRansition <Value>

Sets or queries the negative transition filter. If a bit is set, a 1 to 0 transition in the corresponding bit of the condition register causes a 1 to be written in the corresponding bit of the status register.

Parameters:

<Value> Range: 1 to 65535

STATus:OPERation:PTRansition <Value>

Sets or queries the positive transition filter. If a bit is set, a 0 to 1 transition in the corresponding bit of the condition register causes a 1 to be written in the corresponding bit of the status register.

Parameters:

<Value> Range: 1 to 65535

STATus:OPERation[:EVENT]?

Queries the actions the instrument has executed since the last reading.

Return values:

<OPERation> Range: 1 to 65535

Usage: Query only

13.13.2 Status questionable register

This system contains the commands for controlling the `STATus:QUESTionable` register of the status reporting system.

Queries return the current value of the corresponding register, which permits a check of the device status.

<code>STATus:QUESTionable:CONDition?</code>	229
<code>STATus:QUESTionable:ENABLE</code>	229
<code>STATus:QUESTionable:ENABLE?</code>	229
<code>STATus:QUESTionable:NTRansition</code>	230
<code>STATus:QUESTionable:PTRansition</code>	230
<code>STATus:QUESTionable[:EVENT]?</code>	230

STATus:QUESTionable:CONDition?

Returns the contents of the `CONDition` part of the status register to check for questionable instrument or measurement states. Reading the `CONDition` registers does not delete the contents.

Return values:

<Condition> Condition bits in decimal representation

Range: 1 to 65535

Usage: Query only

STATus:QUESTionable:ENABLE <Enable_value>

Sets the enable mask that allows true conditions in the `EVENT` part to be reported in the summary bit. If a bit in the enable part is set to 1 and its associated event bit transitions to true, a positive transition occurs in the summary bit and is reported to the next higher level.

Parameters:

<Enable_value> Bit mask in decimal representation

Range: 1 to 65535

STATus:QUESTionable:ENABLE?

Queries the enable register and returns a decimal value which corresponds to the binary-weighted sum.

Usage: Query only

STATus:QUESTionable:NTRansition <Value>

Sets or queries the negative transition filter. If a bit is set, a 1 to 0 transition in the corresponding bit of the condition register causes a 1 to be written in the corresponding bit of the event register.

Parameters:

<Value> Bit mask in decimal representation
Range: 1 to 65535

STATus:QUESTionable:PTRansition <Value>

Sets or queries the positive transition filter. If a bit is set, a 0 to 1 transition in the corresponding bit of the condition register causes a 1 to be written in the corresponding bit of the event register.

Parameters:

<Value> Bit mask in decimal representation
Range: 1 to 65535

STATus:QUESTionable[:EVENT]?

Queries the contents of the EVENT part of the status register to check whether an event has occurred since the last reading. Reading an EVENT register deletes its contents.

Return values:

<QUESTionable> Event bits in decimal representation
Range: 1 to 65535

Usage: Query only

13.14 SYSTem subsystem

The SYSTem subsystem contains the commands for general functions which do not directly affect instrument operation.

Example: General instrument settings

The example represents the remote control commands for general settings.

```
// Request information on the instrument configuration.
SYSTem:DEV?
// Response: 'NPA101' // instrument model
SYSTem:HARDware?
// Response: #H40000000 // hardware version
SYSTem:SNUM?
// Response:
SYSTem:VERsion?
// Response: 0x3

// Enable the instrument to create a time stamp
SYSTem:DATE 2020,02,20
SYSTem:DATE?
Response: 2020,2,20
SYSTem:TIME 10,08,41
SYSTem:TIME?
Response: 10,8,41

// Set the sound functionality of the beeper.
//Enable the sound to beep when an error occurs
SYSTem:BEEP:STAT On
SYSTem:BEEP:STATe?
Response: 1

// Disable the sound to beep when the instrument receives a remote control command.
SYSTem:BEEP Off
SYSTem:BEEP?
Response: 0

// Select the interface for remote control.
SYSTem:INTerface LAN
SYSTem:INTerface?
Response: LAN
```

SYSTem:BEEP:STATe.....	232
SYSTem:BEEP:[IMMEDIATE].....	232
SYSTem:DATE.....	232
SYSTem:DEVice?.....	233
SYSTem:ELISt?.....	233
SYSTem:ERRor:ALL?.....	233
SYSTem:ERRor:[NEXT]?.....	233
SYSTem:HARDware?.....	234
SYSTem:INTerface.....	234
SYSTem:LOCAl.....	234
SYSTem:NAME.....	234
SYSTem:REMote.....	235

SYSTem:RWLock.....	235
SYSTem:SET.....	235
SYSTem:SHUTdown.....	235
SYSTem:SNUMber?.....	235
SYSTem:SOFTware?.....	235
SYSTem:TIME.....	235
SYSTem:TREE?.....	236
SYSTem:VERSion?.....	236

SYSTem:BEEPer:STATe <Mode>

Activates the beeper to create an acoustic signal on error.

The query returns the current state.

Parameters:

<boolean> 1 | 0 | ON | OFF
 *RST: ON | 1

Example: See [Example "General instrument settings"](#) on page 231.

Manual operation: See ["Error Beep"](#) on page 152

SYSTem:BEEPer[:IMMEDIATE]

Activates the beeper to create an acoustic signal when a setting is done over remote control.

The query returns the current state.

Parameters:

<boolean> 1 | 0 | ON | OFF
 *RST: ON | 1

Example: See [Example "General instrument settings"](#) on page 231.

Usage: Setting only

Manual operation: See ["CTRL Beep"](#) on page 152

SYSTem:DATE <Year>,<Month>,<Day>

Sets or queries the date for the instrument-internal calendar.

Parameters:

<Year> integer
 <Month> integer
 Range: 1 to 12
 <Day> integer
 Range: 1 to 31

Example: See [Example "General instrument settings"](#) on page 231.

Usage: SCPI confirmed
Manual operation: See "Date" on page 151

SYSTem:DEvice?

Queries the instrument model.

Example: See [Example "General instrument settings"](#) on page 231.

Usage: Query only

SYSTem:ELISt?

Queries the error/event queue for all unread items and removes them from the queue.

See also [SYSTem:ERRor:ALL?](#).

Usage: Query only

SYSTem:ERRor:ALL?

Queries the error/event queue for all unread items and removes them from the queue. The response is a comma separated list of error number and a short description of the error in FIFO order. Positive error numbers are instrument-dependent. Negative error numbers are reserved by the SCPI standard.

Return values:

<ERRor> List of:
 Error/event_number,"Error/event_description>[:Devicedependent info]"
 If the queue is empty, the response is 0,"No error"

Usage: Query only
 SCPI confirmed

SYSTem:ERRor[:NEXT]?

Queries an error and removes it from the queue. Positive error numbers are instrument-dependent. Negative error numbers are reserved by the SCPI standard. If the queue is empty, the response is 0, "No error".

Return values:

<ERRor> 0, "No error"
 -100, "Command error"
 -102, "Syntax error"
 -104, "Data type error"
 -350, "Queue overflow"

Usage: Query only

SYSTem:HARDware?

Queries the instrument hardware version.

Example: See [Example"General instrument settings"](#) on page 231.

Usage: Query only

SYSTem:INTerface <interface>

Selects the interface for remote control.

Parameters:

<Interface> LAN | GPIB | USB CDC | USB TMC

LAN

Selects the Ethernet (LAN) interface for remote control.

GPIB

Selects the IEEE488 interface for remote control.

USB CDC

Selects the USB interface for remote control over the VCP port with CDC protocol (requires USB-VCP driver).

USB TMC

Selects the USB interface for remote control with TMC protocol (requires VISA library).

Example: See [Example"General instrument settings"](#) on page 231

Usage: SCPI confirmed

Manual operation: See ["USB TMC"](#) on page 172
See ["ETHERNET"](#) on page 173
See ["IEEE488"](#) on page 176

SYSTem:LOCal

Sets the system to front panel control. The front panel control is unlocked. If the front panel control was locked with [SYSTem:RWLock](#), the message box of the locked front panel on the display is closed.

Usage: Setting only

SYSTem:NAME <Name>

Defines or queries the instrument name.

Parameters:

<Name> String with max. 20 characters.

Example: SYSTem:NAME 'TEST UNIT'
SYSTem:NAME?
<-- TEST UNIT

SYSTem:REMOte

Sets the system to remote state. The front panel control is locked.

To activate the front panel control, use the softkey button UNLOCK KEYS.

Usage: Setting only

SYSTem:RWLock

Sets the system to remote state. The front panel control is locked and a message box is shown on the instrument display.

To unlock the front panel control, use [SYSTem:LOCa1](#).

Usage: Setting only

SYSTem:SET <block data>

Sets the current instrument state in form of definite binary block data.

Example: See [Example"General instrument settings"](#) on page 231

Usage: SCPI confirmed

SYSTem:SHUTdown

Turns off the instrument and sets it in standby mode. The instrument cannot be enabled remotely.

Usage: Setting only

SYSTem:SNUMber?

Queries the instrument serial number.

Example: See [Example"General instrument settings"](#) on page 231.

Usage: Query only

SYSTem:SOFTware?

Queries the instrument firmware version.

Example: See [Example"General instrument settings"](#) on page 231.

Usage: Query only

SYSTem:TIME <Hour>,<Minute>,<Second>

Sets or queries the time for the instrument-internal clock.

The R&S NPA indicates the time also in the status bar.

Parameters:

<Hour>	integer
	Range: 0 to 23
	Default unit: h
<Minute>	integer
	Range: 0 to 59
	Default unit: min
<Second>	integer
	Range: 0 to 59
	Default unit: s

Example: See [Example "General instrument settings"](#) on page 231.

Usage: SCPI confirmed

Manual operation: See ["Time"](#) on page 151

SYSTem:TREE?

Returns a list of implemented remote commands.

Usage: Query only

SYSTem:VERSion?

Returns the firmware version and the version of the SCPI standard.

Usage: Query only

Manual operation: See ["Device Information"](#) on page 150

13.15 VIEW subsystem

The subsystem contains the commands for configuring the parameters of the display modes.

Example: View settings

The example represents the remote control commands for configuring the display of the measurement results.

```

*****
// Numeric mode
*****
// Configure the parameters:
// select numeric display and set the number
// of cells for display, the measurement
// parameters and position.
// activate display of measurement page 1
*****
VIEW NUMeric
VIEW:NUMeric:PAGe1:SIZE 6
VIEW:NUMeric:PAGe1:CELL1:FUNCTion P
VIEW:NUMeric:PAGe1:CELL2:FUNCTion S
VIEW:NUMeric:PAGe1:CELL3:FUNCTion Q
VIEW:NUMeric:PAGe1:CELL4:FUNCTion LAMBda
VIEW:NUMeric:PAGe1:CELL5:FUNCTion PHI
VIEW:NUMeric:PAGe1:CELL6:FUNCTion FU
VIEW:NUMeric[:SHOW] 1

*****
// Query the settings:
VIEW?
// Response: NUM
VIEW:NUMeric:PAGe1:SIZE?
// Response: 6
VIEW:NUMeric:PAGe1:CELL5:FUNCTion?
// Response: PHI

*****
// Harmonics mode
*****
// Configure the parameters:
// select harmonics bar graph display
// set number of harmonics and the type of
// harmonics to be included in FFT calculation
// select the source and scaling factor.
*****
VIEW HARMonics
VIEW:HARMonics:VIEW BAR
VIEW:HARMonics:SOURce VOLTage
VIEW:HARMonics:NUMBer 15
VIEW:HARMonics:SCALing ABSolut
VIEW:HARMonics:SUBSet ALL

*****
// Query the settings:

```

```

VIEW?
// Response: HARmonics
VIEW:HARMonics:VIEW?
// Response: BAR
VIEW:HARMonics:SOURce?
// REsponse: VOLTage
VIEW:HARMonics:NUMBer?
// Repsonse: 15
VIEW:HARMonics:SCALing?
// Repsonse: ABSolut
VIEW:HARMonics:SUBSet?
// Response: ALL

// Query the maximum number of harmonics
VIEW:HARMonics:NUMBer? MAX
// Response: 50

*****
// Waveform mode
*****
// Configure the parameters:
// select waveform display mode
// set all parameters visible on the screen
*****

VIEW WAVEform
VIEW:WAVEform:VOLTage 1
VIEW:WAVEform:CURREnt 1
VIEW:WAVEform:POWER 1
VIEW:WAVEform:READOut 1

*****
// Query the settings:
VIEW?
// Response: WAVEform
VIEW:WAVEform:VOLTage?
// Response: 1
VIEW:WAVEform:CURREnt?
// Response: 1
VIEW:WAVEform:POWER?
// Response: 1
VIEW:WAVEform:READOut?
// Response: 1

*****
// Trendchart mode
*****
// Configure the parameters:

```

```

// select trendchart display
// select the source parameters and the
// time scaling of the display
// activate the graphical display
// of both sources
// reset the screen and restart the trace.
*****

VIEW TRENDchart
VIEW:TRENDchart:SOURce 1
VIEW:TRENDchart:TIMEbase 60
VIEW:TRENDchart:VISible1 1
VIEW:TRENDchart:VISible2 1
VIEW TRENDchart:CLEar

*****
// Query the settings:
VIEW?
// Response: TRENDchart
VIEW:TRENDchart:SOURce?
// Response: 1
VIEW:TRENDchart:TIMEbase?
// Response: 60
VIEW:TRENDchart:VISible1?
// Response: 1
VIEW:TRENDchart:VISible2?
// Response: 1

*****
// Inrush mode
*****
// Configure the parameters:
// select inrush display mode
// set voltage and current visible
*****

VIEW INRush
VIEW:INRush:CURRent 1
VIEW:INRush:VOLTage 1
CHANnel[:ACQuisition]:INRush:TRIGger MANual
CHANnel[:ACQuisition]:INRush:TIME 2.0
CHANnel[:ACQuisition]:INRush:ACTivate 1

*****
// Example for settings triggered by the voltage trace
// CHANnel[:ACQuisition]:INRush:TRIGger VOLTage
// CHANnel[:ACQuisition]:INRush:VOLTage:SLOPe RISing
// CHANnel[:ACQuisition]:INRush:VOLTage:LEVel 0.5

```

```

*****
// Example for settings triggered by the current trace
// CHANnel[:ACQuisition]:INRush:TRIGger CURRent
// CHANnel[:ACQuisition]:INRush:CURRent:SLOPe FALLing
// CHANnel[:ACQuisition]:INRush:CURRent:LEVel 0.1

*****

// Query the settings:
VIEW?
// Response: INRush
VIEW:INRush:VOLTagE?
// Response: 1
VIEW:INRush:CURRent?
// Response: 1
CHANnel[:ACQuisition]:INRush:TRIGger?
// Response: MANual
CHANnel[:ACQuisition]:INRush:TIME?
// Response: 2.0
CHANnel[:ACQuisition]:INRush:ACTivate?
// Response: 1

```

13.15.1 Display mode commands

VIEW.....	241
VIEW:HARMonics:NUMber.....	241
VIEW:HARMonics:SCALing.....	241
VIEW:HARMonics:SOURce.....	241
VIEW:HARMonics:SUBSET.....	242
VIEW:HARMonics:VIEW.....	242
VIEW:INRush:CURRent.....	242
VIEW:INRush:VOLTagE.....	243
VIEW:NUMeric:PAGE<n>:CELL<m>:FUNCTion.....	243
VIEW:NUMeric:PAGE<n>:SIZE.....	243
VIEW:NUMeric[:SHOW].....	244
VIEW:TRENdchart:CLEar.....	244
VIEW:TRENdchart:SOURce<n>.....	244
VIEW:TRENdchart:TIMEbase.....	244
VIEW:TRENdchart:VISible<n>.....	245
VIEW:WAVEform:CURRent.....	245
VIEW:WAVEform:POWer.....	245
VIEW:WAVEform:READOut.....	245
VIEW:WAVEform:VOLTagE.....	245

VIEW <Mode>

Selects the display mode.

Parameters:

<Mode> NUMeric | HARMonics | TRENDchart | WAVeform | INRush

NUMeric

Displays the measurement results numerically.

HARMonics

Displays the harmonics of current and voltage.

TRENDchart

Displays current or voltage as a signal profile.

WAVeform

Displays the waveform for one cycle of voltage, current or power data.

INRush

Displays a single shot of a signal profile.

*RST: NUMeric

Example: See [Example"View settings"](#) on page 237.

VIEW:HARMonics:NUMber <Number>

Sets the number of harmonics for FFT calculation.

Parameters:

<Number> integer
Range: 5 to 50

Example: See [Example"View settings"](#) on page 237.

Manual operation: See ["NUMBER"](#) on page 114

VIEW:HARMonics:SCALing <Scaling>

Selects the scaling factor for the harmonics view.

Parameters:

<View> ABSolut | PERCent

Example: See [Example"View settings"](#) on page 237.

Manual operation: See ["SCALING"](#) on page 114

VIEW:HARMonics:SOURce <Source>

Selects the parameter for FTT calculation.

Parameters:

<Source> VOLTage | CURRent | BOTH

VOLTage

Uses the voltage for FTT calculation.

CURRent

Uses the current for FTT calculation.

BOTH

Uses both parameters.

Example: See [Example"View settings"](#) on page 237.

Manual operation: See ["SOURCE"](#) on page 113

VIEW:HARMonics:SUBSET <View>

Selects the harmonics for display.

Parameters:

<View> EVEN | ODD | ALL

EVEN

Displays the even harmonics.

ODD

Displays the odd harmonics.

ALL

Displays the all harmonics.

Example: See [Example"View settings"](#) on page 237.

Manual operation: See ["SUBSET"](#) on page 114

VIEW:HARMonics:VIEW <View>

Selects the display of the measurement results in the harmonics mode.

Parameters:

<View> BAR | TABLE

BAR

Displays the harmonics of current or voltage in a bar graph.

TABLE

Displays the measurement results of the harmonics in a table.

Example: See [Example"View settings"](#) on page 237.

Manual operation: See ["VIEW SELECT"](#) on page 113

VIEW:INRush:CURRent <State>

Displays the trace of the current in the inrush diagram.

Parameters:

<State> 1 | 0 | ON | OFF

Example: See [Example"View settings"](#) on page 237.

Manual operation: See ["VISIBLE"](#) on page 124

VIEW:INRush:VOLTage <State>

Displays the trace of the voltage in the inrush diagram.

Parameters:

<State> 1 | 0 | ON | OFF

Example: See [Example"View settings"](#) on page 237.

Manual operation: See ["VISIBLE"](#) on page 124

VIEW:NUMeric:PAGE<n>:CELL<m>:FUNction <Parameter>

Selects the measurement parameter for display in numeric mode. The page index and cell index assign the measurement page and position to the parameter.

Suffix:

<n> 1 to 4
Selects the configuration page.

<m> 1 to 6 or 1 to 10, depending on the page size.
Selects the configuration cell.
To set the page size, use the command `VIEW:NUMeric:PAGE<n>:SIZE`.

Parameters:

<Parameter> AH | AHM | AHP | | EMPTy | FI | FPLL | FU | IAVG | IRANge | IRMS | ITHD | LAMBda | P | PHI | Q | S | TIME | UAVG | URANge | URMS | UTHD | WH | WHM | WHP

See [Chapter 5.1, "Measurement parameters"](#), on page 54 for the list of parameters including designation and units.

Example: See [Example"View settings"](#) on page 237.

Manual operation: See ["1, 2, 3, 4"](#) on page 110

VIEW:NUMeric:PAGE<n>:SIZE <Size>

Selects the number of measurement cells for the selected configuration page in numeric mode.

Suffix:

<n> 1 to 4
Selects the configuration page.

Parameters:

<Size> 6 | 10
Sets the number of measurement cells of the selected page for display.

Example: See [Example"View settings"](#) on page 237.

Manual operation: See "1, 2, 3, 4" on page 110

VIEW:NUMeric[:SHOW] <Page>

Selects the configuration page in numeric mode.

Parameters:

<Page> 1 | 2 | 3 | 4
 Range: 1 to 4

Example: See [Example"View settings"](#) on page 237.

Manual operation: See "1, 2, 3, 4" on page 110

VIEW:TRENDchart:CLEAr

Deletes the trace data and restarts acquisition.

Example: See [Example"View settings"](#) on page 237.

Usage: Setting only

Manual operation: See "CLEAR" on page 118

VIEW:TRENDchart:SOURce<n> <Parameter>

Selects the source for the trendchart display mode.

Suffix:

<n> 1 to 2
 Selects the source.

Parameters:

<Parameter> AIN | DIN | ITHD | FI | FPLL | FU | IAVG | IRMS | P | PHI | Q | S |
 UAVG | URMS | UTHD

Example: See [Example"View settings"](#) on page 237.

Manual operation: See "SCR1, SCR2" on page 118

VIEW:TRENDchart:TIMEbase <Timebase>

Sets the time grid of the trendchart diagram.

Parameters:

<Timebase> 5 | 10 | 60 | 600
 Default unit: s/Div

Example: See [Example"View settings"](#) on page 237.

Manual operation: See "TIME BASE" on page 119

VIEW:TRENDchart:VISible<n> <State>

Displays the trace of the source in the trendchart diagram.

Suffix:

<n> 1|2
Source index.

Parameters:

<State> 1 | 0 | ON | OFF

Example: See [Example"View settings"](#) on page 237.

Manual operation: See ["VISIBLE"](#) on page 119

VIEW:WAVeform:CURRent <State>

Activates the display of the current trace.

Parameters:

<State> 1 | 0 | ON | OFF

Example: See [Example"View settings"](#) on page 237.

Manual operation: See ["CURRENT"](#) on page 116

VIEW:WAVeform:POWer <State>

Activates the display of the power trace.

Parameters:

<State> 1 | 0 | ON | OFF

Example: See [Example"View settings"](#) on page 237.

Manual operation: See ["POWER"](#) on page 116

VIEW:WAVeform:READout <State>

Displays statistical vaules in the waveform diagram.

Parameters:

<State> 1 | 0 | ON | OFF

Example: See [Example"View settings"](#) on page 237.

Manual operation: See ["READOUTS"](#) on page 116

VIEW:WAVeform:VOLTage <State>

Activates the display of the voltage trace.

Parameters:

<State> 1 | 0 | ON | OFF

Example: See [Example"View settings"](#) on page 237.

Manual operation: See ["VOLTAGE"](#) on page 116

13.15.2 Inrush acquisition commands

CHANnel[:ACQuisition]:INRush:ACTivate	246
CHANnel[:ACQuisition]:INRush:CURRent:LEVel	246
CHANnel[:ACQuisition]:INRush:CURRent:SLOPe	246
CHANnel[:ACQuisition]:INRush:TIME	246
CHANnel[:ACQuisition]:INRush:TRIGger	247
CHANnel[:ACQuisition]:INRush:VOLTag:e:LEVel	247
CHANnel[:ACQuisition]:INRush:VOLTag:e:SLOPe	247

CHANnel[:ACQuisition]:INRush:ACTivate <State>

Activates the inrush measurement.

Parameters:

<State> 1 | 0 | ON | OFF

ON

Starts the measurement.

OFF

Stops the measurement and discards the recorded data.

Example: See [Example"View settings"](#) on page 237.

Manual operation: See ["ACTIVATE"](#) on page 124

CHANnel[:ACQuisition]:INRush:CURRent:LEVel <Value>

Sets the level of the current trace to generate the trigger event.

Parameters:

<Value> Default unit: V

Example: See [Example"View settings"](#) on page 237.

Manual operation: See ["LEVEL"](#) on page 125

CHANnel[:ACQuisition]:INRush:CURRent:SLOPe <Slope>

Sets the polarity of the edge for the current signal that triggers the measurement.

Parameters:

<Slope> RISing | FALLing

Example: See [Example"View settings"](#) on page 237.

Manual operation: See ["SLOPE"](#) on page 125

CHANnel[:ACQuisition]:INRush:TIME <Acquisition_time>

Selects the time period for inrush measurement.

Parameters:

<Acquisition_time> 0.016 | 0.032 | 0.064 | 0.130 | 0.260 | 0.520 | 1.0 | 2.0 | 4.0 | 8.0 | 16.0 | 33.0 | 67.0

Default unit: s

Example:

See [Example"View settings"](#) on page 237.

Manual operation:

See ["ACQ TIME"](#) on page 124

CHANnel[:ACQuisition]:INRush:TRIGger <Trigger>

Selects the trigger mode for the inrush view.

Parameters:

<Trigger> MANual | VOLTage | CURRent

Example:

See [Example"View settings"](#) on page 237.

Manual operation:

See ["TRIGGER"](#) on page 124

CHANnel[:ACQuisition]:INRush:VOLTage:LEVeI <Value>

Sets the level of the voltage trace to generate the trigger event.

Parameters:

<Value> Default unit: V

Example:

See [Example"View settings"](#) on page 237.

Manual operation:

See ["LEVEL"](#) on page 125

CHANnel[:ACQuisition]:INRush:VOLTage:SLOPe <Slope>

Sets the polarity of the edge for the voltage signal that triggers the measurement.

Parameters:

<Slope> RISing | FALLing

Example:

See [Example"View settings"](#) on page 237.

Manual operation:

See ["SLOPE"](#) on page 125

14 Troubleshooting and notifications

- [Displaying status information and notifications](#)..... 248
- [Problems during firmware update](#)..... 248
- [Problems with remote control over LAN](#)..... 249
- [Contacting customer support](#)..... 249

14.1 Displaying status information and notifications

The R&S NPA displays notifications to inform you on current settings and states. It distinguishes between status, information and error notifications and warnings.

Some information and notifications are entered in the error/event queue of the status reporting system, see [Chapter 12.1.4, "Status reporting system"](#), on page 167.

14.2 Problems during firmware update

The firmware update is described in [Chapter 11.1, "Update \(firmware\)"](#), on page 146.

Solutions for potential problems that can occur during firmware update are described in the following sections.

Firmware update was interrupted

If for example, a power cut happened during the firmware update, problems can occur.

1. Perform the firmware update again. Sometimes, a further update fixes the problems.
2. If you nevertheless cannot update the R&S NPA, contact the local service representative, see [Chapter 14.4, "Contacting customer support"](#), on page 249.

Firmware update was aborted

If there is not enough free memory space, the firmware update aborts. The instrument displays an error message.

- ▶ Start the firmware update again.

14.3 Problems with remote control over LAN

14.3.1 Cannot establish a LAN connection

If you have problems to establish a LAN connection as described in [Chapter 3.1.8, "Connecting to LAN"](#), on page 24:

1. Check if the TCP/IP address information is valid.
2. Assign the IP address manually, e.g. if the network does not support DHCP configuration, see [Chapter 12.4, "Adjusting the interface addresses"](#), on page 177.

14.3.2 Cannot communicate over LAN

If you have problems to establish the LAN communication:

1. Refer to the application note [1SL374: How to communicate with R&S devices using VISA](#), that provides comprehensive information on configuring the interfaces, required drivers, and testing the communication.
2. If you still have problems, contact the customer support.

14.4 Contacting customer support

Technical support – where and when you need it

For quick, expert help with any Rohde & Schwarz product, contact our customer support center. A team of highly qualified engineers provides support and works with you to find a solution to your query on any aspect of the operation, programming or applications of Rohde & Schwarz products.

Contact information

Contact our customer support center at www.rohde-schwarz.com/support, or follow this QR code:



Figure 14-1: QR code to the Rohde & Schwarz support page

15 Transporting

For safety information, see:

- ["Lifting and carrying the product"](#) on page 10
- [.Chapter 3.1.1, "Lifting and carrying"](#), on page 18

Packing

Use the original packaging material. It consists of antistatic wrap for electrostatic protection and packing material designed for the product.

If you do not have the original packaging, use similar materials that provide the same level of protection. You can also contact your local Rohde & Schwarz service center for advice.

Securing

When moving the product in a vehicle or using transporting equipment, make sure that the product is properly secured. Only use items intended for securing objects.

Transport altitude

The maximum transport altitude without pressure compensation is specified in the specifications document.

16 Maintenance, storage and disposal

The product does not require regular maintenance. It only requires occasional cleaning. It is however advisable to check the nominal data from time to time.

16.1 Cleaning

How to clean the product is described in "[Cleaning the product](#)" on page 12.

Do not use any liquids for cleaning. Cleaning agents, solvents, acids and bases can damage the front panel labeling, plastic parts and display.

16.2 Changing fuses

If the R&S NPA does not start, it is possible that a blown fuse is the cause. Proceed as described in [Preparing for mains voltage](#) > "[To change the fuse](#)" on page 22.

16.3 Storage

Protect the product against dust. Ensure that the environmental conditions, e.g. temperature range and climatic load, meet the values specified in the specifications document.

16.4 Disposal

Rohde & Schwarz is committed to making careful, ecologically sound use of natural resources and minimizing the environmental footprint of our products. Help us by disposing of waste in a way that causes minimum environmental impact.

Disposing of electrical and electronic equipment

A product that is labeled as follows cannot be disposed of in normal household waste after it has come to the end of its life. Even disposal via the municipal collection points for waste electrical and electronic equipment is not permitted.



Figure 16-1: Labeling in line with EU directive WEEE

Rohde & Schwarz has developed a disposal concept for the eco-friendly disposal or recycling of waste material. As a manufacturer, Rohde & Schwarz completely fulfills its

obligation to take back and dispose of electrical and electronic waste. Contact your local service representative to dispose of the product.

Glossary: List of often used terms and abbreviations

C

CDC: Communications device class: protocol used for emulating serial ports over USB.

Computer name: An unambiguous indication of the instrument a LAN that uses a [DNS](#) server.

The default computer name follows the syntax `<instrument>-<serial number>`, e.g. `NPA701-112233`.

Synonym: [Hostname](#)

See [Serial number](#).

D

DHCP: Dynamic host configuration protocol

DNS: Domain name system server

E

e.g.: For example

F

FFT: "Fast Fourier Transformation"

A mathematical algorithm to convert a signal, e.g. from the time domain to the frequency domain and vice versa. You can use this method to represent the time-dependent behaviour of the the signal power.

G

Glossary: List of the often used terms and abbreviations

GPIB: General purpose interface bus: digital interface system, used to control an instrument remotely or transfer data between two or more instruments.

GUI: Graphical user interface

H

Hostname: [Computer name](#)

I

i.e.: That is

IEC 625/IEEE 488: [GPIB](#)

L

Line voltage: AC voltage of the network.
Synonyms: Mains voltage

O

OSA: Open source acknowledgment documentation embedded in the instrument firmware.

P

PC: Personal computer

product page: A designation of the R&S NPA product page.

R

Remote control: The operation of the R&S NPA by remote control commands or programs to perform automated tests.
The instrument is connected to a system controller via LAN/VXI-11, GPIB or USB using [VISA](#). The instrument is controlled directly or supported by instrument drivers.

Remote device: External device controls the R&S NPA in remote operation mode, see Remote operation.
Synonyms: External controller, client device

S

SCPI: Standard commands for programmable instruments.

Serial number: Unique instrument identification, provided on the rear panel of the instrument and required to build the [Computer name](#).

The serial number are the last 6 digits in the string `<stock no.>-<serial number>`, e.g. NPA701-112233

T

TCP/IP: Transmission control protocol / Internet protocol for communication of devices in a network (Internet or private network).

U

URL: Uniform resource locator: address string for unique identification of a device connected to a network.

USB: Universal bus interface

USBTMC: USB test & measurement class specification: a protocol that is built on top of USB for communication with USB devices.

V

VCP: Virtual COM port

Synonym: [CDC](#)

VISA: Virtual instrument software architecture for communication over various interfaces, e.g. Ethernet, LAN or USB.

VISA library: Standardized I/O software interface library for communication of devices over TCP/IP protocols.

List of commands

*CLS.....	185
*ESE.....	185
*ESR?.....	186
*IDN?.....	186
*LRN?.....	186
*OPC.....	186
*PSC.....	186
*RCL <Storage>.....	187
*RST.....	187
*SAV <Storage>.....	187
*SRE.....	187
*STB?.....	187
*TRG.....	188
*TST?.....	188
*WAI.....	188
CHANnel:LIMit<n>:HIGH.....	208
CHANnel:LIMit<n>:LOW.....	208
CHANnel:LIMit<n>:PERCent?.....	208
CHANnel:LIMit<n>:SOURce.....	209
CHANnel:LIMit<n>[:STATe].....	209
CHANnel:LIMit<n>RESult[:STATe].....	209
CHANnel:MEASurement:DATA?.....	211
CHANnel:MEASurement:FORMat.....	211
CHANnel:MEASurement:FUNCTions.....	211
CHANnel:MEASurement:FUNCTions:COUNT??.....	212
CHANnel:MEASurement:INRush:CURRent[:DATA]??.....	212
CHANnel:MEASurement:INRush:VOLTag[:DATA]??.....	212
CHANnel:MEASurement:WAVeform:CURRent[:DATA]??.....	212
CHANnel:MEASurement:WAVeform:VOLTag[:DATA]??.....	213
CHANnel:NAME.....	213
CHANnel[:ACQuisition]:CURRent:CFACtor.....	192
CHANnel[:ACQuisition]:CURRent:INVert.....	192
CHANnel[:ACQuisition]:CURRent:PROTection:RESet.....	192
CHANnel[:ACQuisition]:CURRent:PROTection?.....	193
CHANnel[:ACQuisition]:CURRent:RANGe.....	193
CHANnel[:ACQuisition]:CURRent:RANGe:AUTO.....	193
CHANnel[:ACQuisition]:INRush:ACTivate.....	246
CHANnel[:ACQuisition]:INRush:CURRent:LEVel.....	246
CHANnel[:ACQuisition]:INRush:CURRent:SLOPe.....	246
CHANnel[:ACQuisition]:INRush:TIME.....	246
CHANnel[:ACQuisition]:INRush:TRIGger.....	247
CHANnel[:ACQuisition]:INRush:VOLTag:LEVel.....	247
CHANnel[:ACQuisition]:INRush:VOLTag:SLOPe.....	247
CHANnel[:ACQuisition]:MODE.....	194
CHANnel[:ACQuisition]:MODE[:AC]:PLL.....	194
CHANnel[:ACQuisition]:MODE[:FILTer]:ANALog.....	194
CHANnel[:ACQuisition]:MODE[:FILTer]:DIGital.....	195

CHANnel[:ACQuisition]:MODE[:FILTer]:FREQuency.....	195
CHANnel[:ACQuisition]:PEAKhold:ACTivate.....	195
CHANnel[:ACQuisition]:PEAKhold:RESet.....	195
CHANnel[:ACQuisition]:VOLTag:e:CFACTOR.....	196
CHANnel[:ACQuisition]:VOLTag:e:INVert.....	196
CHANnel[:ACQuisition]:VOLTag:e:RANGe.....	196
CHANnel[:ACQuisition]:VOLTag:e:RANGe:AUTO.....	196
CHANnel[:EXTErn]:AINPut[:STATe].....	202
CHANnel[:EXTErn]:AOUTput:MODE.....	202
CHANnel[:EXTErn]:AOUTput[:STATe].....	203
CHANnel[:EXTErn]:DINPut:INVert.....	203
CHANnel[:EXTErn]:DINput:MODE.....	203
CHANnel[:EXTErn]:DINPut[:STATe].....	204
CHANnel[:EXTErn]:DOUput:INVert.....	204
CHANnel[:EXTErn]:DOUput:MODE.....	204
CHANnel[:EXTErn]:DOUput[:STATe].....	204
CHANnel[:EXTErn]:SENSor:CCLamp[:RATio].....	205
CHANnel[:EXTErn]:SENSor:EXTShunt[:RESistance].....	205
CHANnel[:EXTErn]:SENSor:MODE.....	205
CHANnel[:EXTErn]:SENSor:RANGe.....	206
CHANnel[:EXTErn]:SENSor[:STATe].....	205
DATA:DATA?.....	214
DATA:DELeTe.....	215
DATA:LIST?.....	215
DATA:POINts?.....	215
DISPlay:TEXT:CLEar.....	216
DISPlay:TEXT[:DATA].....	217
DISPlay[:STATe].....	216
HCOPY:DATA?.....	217
HCOPY:FORMat.....	218
HCOPY:SIZE:X?.....	218
HCOPY:SIZE:Y?.....	218
INTEgrator:DURation.....	220
INTEgrator:MODE.....	221
INTEgrator:RESet.....	221
INTEgrator:STARt.....	221
INTEgrator:STIME.....	222
INTEgrator:STOP.....	222
INTEgrator[:STATe].....	222
LOG:COUNT.....	225
LOG:DURation.....	225
LOG:FNAME.....	225
LOG:INTErval.....	226
LOG:MODE.....	226
LOG:PAGE.....	226
LOG:STIME.....	227
LOG[:STATe].....	227
STATus:OPERation:CONDition?.....	228
STATus:OPERation:ENABLE.....	228
STATus:OPERation:NTRansition.....	228

STATus:OPERation:PTRansition.....	228
STATus:OPERation[:EVENT]?.....	229
STATus:QUEStionable:CONDition?.....	229
STATus:QUEStionable:ENABle.....	229
STATus:QUEStionable:ENABle?.....	229
STATus:QUEStionable:NTRansition.....	230
STATus:QUEStionable:PTRansition.....	230
STATus:QUEStionable[:EVENT]?.....	230
SYSTem:BEEPer:STATe.....	232
SYSTem:BEEPer[:IMMEdiate].....	232
SYSTem:DATE.....	232
SYSTem:DEVIce?.....	233
SYSTem:ELISt?.....	233
SYSTem:ERRor:ALL?.....	233
SYSTem:ERRor[:NEXT]?.....	233
SYSTem:HARDWare?.....	234
SYSTem:INTerface.....	234
SYSTem:LOCal.....	234
SYSTem:NAME.....	234
SYSTem:REMote.....	235
SYSTem:RWLock.....	235
SYSTem:SET.....	235
SYSTem:SHUTdown.....	235
SYSTem:SNUMber?.....	235
SYSTem:SOFTWare?.....	235
SYSTem:TIME.....	235
SYSTem:TREE?.....	236
SYSTem:VERSion?.....	236
VIEW.....	241
VIEW:HARMonics:NUMber.....	241
VIEW:HARMonics:SCALing.....	241
VIEW:HARMonics:SOURce.....	241
VIEW:HARMonics:SUBSET.....	242
VIEW:HARMonics:VIEW.....	242
VIEW:INRush:CURRent.....	242
VIEW:INRush:VOLTage.....	243
VIEW:NUMeric:PAGE<n>:CELL<m>:FUNCTion.....	243
VIEW:NUMeric:PAGE<n>:SIZE.....	243
VIEW:NUMeric[:SHOW].....	244
VIEW:TRENDchart:CLEar.....	244
VIEW:TRENDchart:SOURce<n>.....	244
VIEW:TRENDchart:TIMEbase.....	244
VIEW:TRENDchart:VISible<n>.....	245
VIEW:WAVEform:CURRent.....	245
VIEW:WAVEform:POWEr.....	245
VIEW:WAVEform:READout.....	245
VIEW:WAVEform:VOLTage.....	245

Index

A

- About
 - CSV 158
 - AC supply
 - How to connect 24
 - Accept storage settings
 - Logging 89
 - Access
 - Acquisition mode 60, 64
 - Acquisition mode settings 68, 71
 - CSV settings 158
 - Current acquisition settings 67
 - Data and time settings 151
 - Device information 149
 - Device name settings 156, 160
 - Display modes 107
 - Display settings 152
 - External mode 128
 - Firmware update 147
 - Harmonics view 110
 - Inrush view 120
 - Integrator 72
 - Key brightness settings 154
 - Limit settings 92
 - Numeric view 108
 - Peak hold setting 70
 - Sound settings 152
 - Standard settings 95
 - Trendchart view 116
 - Voltage acquisition settings 65
 - Waveform view 114
 - Access acquisition mode
 - Acquisition 65
 - Access current settings
 - Acquisition 64
 - Access peak hold settings
 - Acquisition 65
 - Access voltage settings
 - Acquisition 64
 - Accessing dialogs 44
 - Accessing functionality 42
 - Accessing menus 44
 - Acquisition 64
 - Access acquisition mode 65
 - Access current settings 64
 - Access peak hold settings 65
 - Access voltage settings 64
 - Activate peak hold 70
 - Current autorange 67
 - Current crest factor 68
 - Current invert 68, 70
 - Current range 67
 - Current settings 67
 - Digital filter 70
 - Frequency filter 69
 - How to: configure integrator 74
 - How to: configure integrator duration mode 77
 - How to: configure integrator external mode 78
 - How to: configure integrator span mode 76
 - How to: Mode settings 61
 - How to: select integrator parameters 73
 - How to: Voltage & current settings 60
 - Mode 69
 - Mode settings 68
 - Peak hold settings 70
 - PLL source 69
 - Refresh 71
 - Reset peak hold 71
 - Voltage autorange 66
 - Voltage crest factor 66
 - Voltage invert 66
 - Voltage range 66
 - Voltage settings 65
 - Acquisition time
 - Inrush view 124
 - Activate
 - Analog input 129
 - Analog output 129
 - Digital input 131
 - Digital output 131
 - Inrush view 124
 - Integrator 78
 - Limit 94
 - Logging 86
 - Peak hold 70
 - Sensor measurement 133
 - Alphanumeric data 45
 - How to enter 45
 - Application cards 17
 - Application notes 17
 - Arrow keys 43
- ## B
- Back key 43
 - Bar graph
 - Harmonics view 113
 - Beeper 151
 - Bench top, placing the R&S NPA 19
 - Brightness
 - Display 154
 - Keys 156
 - Setup 154
 - Brochures 16
 - Browser
 - Logging 89
- ## C
- Cable selection
 - Test setup considerations 21
 - Calibration certificate 17
 - Carrying the instrument 18
 - Change directory
 - Logging 88
 - CHANnel:ACQuisition subsystem
 - Remote control commands 188
 - CHANnel:EXtErnal subsystem
 - Remote control commands 197
 - CHANnel:LIIMit subsystem
 - Remote control commands 206
 - CHANnel:MEASurement subsystem
 - Remote control commands 209
 - CHANnel:NAME subsystem
 - Remote control commands 213

- Checking the instrument 18
 - Clamp-on current probe
 - How to: configure measurement 136
 - Clamp-on probe
 - Configuring 134
 - Setup 52
 - Class
 - Standards 97
 - Clear
 - Trendchart view 118
 - Clear status
 - Remote 185
 - Command sequence
 - Remote 188
 - Commands
 - Remote control 184
 - Common input
 - Connector 33
 - Complete a measurement
 - Trying out 102
 - Configure measurement
 - Trying out 98
 - Configuring
 - Clamp-on probe 134
 - Shunt 134
 - Connect to AC supply
 - How to 24
 - Connect to GPIB (IEC 625/IEEE 488)
 - How to: connect for remote control 177
 - Connect to ground
 - How to 23
 - Connect to LAN
 - How to 25
 - Connecting
 - LAN 24
 - Memory stick 26
 - Power 23
 - USB devices 26
 - Connecting a device under test 26
 - Connecting a DUT directly
 - Setup 51
 - Connector
 - AC power supply 36
 - Analog In/Out 35
 - Common input 33
 - Current input 33
 - Digital In/Out 35
 - GPIB 35
 - IEC/IEEE 35
 - LAN 36
 - USB A 34
 - USB B 36
 - Voltage input 33
 - Connectors
 - Front panel 33
 - Rear panel 35
 - Considerations
 - Setting up 21
 - Contrast
 - General functions 153
 - Setup 154
 - Control beep
 - Setup 152
 - Conventions
 - SCPI 184
 - Count
 - Logging 87
 - Create directory
 - Logging 89
 - CSV
 - About 158
 - General functions 157
 - General instrument settings 159
 - Logging 89
 - Settings 158
 - CSV export
 - Inrush view 125
 - CSV settings
 - Decimal separator 159
 - Error value 159
 - Field delimiter 159
 - Line separator 159
 - Current
 - Input connector 33
 - Waveform view 116
 - Current autorange
 - Acquisition 67
 - Current crest factor
 - Acquisition 68
 - Standards 97
 - Current invert
 - Acquisition 68, 70
 - Current range
 - Acquisition 67
 - Standards 97
 - Current settings
 - Acquisition 67
 - Current time
 - Integrator 79
 - Logging 87
 - Current-based measurement
 - Setup 50
 - Customer support 249
 - Cycle
 - Standards 97
- ## D
- Data acquisition settings 64
 - Data entry 44
 - Data logging
 - See logging 80
 - Data sheets 16
 - DATA subsystem
 - Remote control commands 213
 - Date
 - General functions 151
 - Setting 29
 - Setup 151
 - Decimal separator
 - CSV settings 159
 - Default
 - General instrument settings 161
 - Default values
 - Remote 187
 - Device information
 - General functions 149
 - Setup 150
 - Device name
 - General functions 156
 - Miscellaneous 157
 - DHCP 177
 - Digital filter
 - Acquisition 70

Digital input and output		
External	130	
Direct connection of the DUT		
How to	51	
Display		
Brightness	153, 154	
Characteristics	41	
Contrast	153, 154	
Front panel	31	
General functions	152	
Grid intensity	153, 154	
Harmonics view	110	
How to: customize screen appearance	153	
How to: leave view	108	
Indicators	41	
Inrush view	119	
Key brightness	156	
Key fallback time	156	
Modes	107	
Numeric view	108	
Screen intensity	153	
Select harmonics view	113	
Select measurement page	110	
Trendchart view	116	
Waveform view	114	
Display information	41	
DISPlay subsystem		
Remote control commands	216	
Driver for remote control	17	
Duration		
Integrator	80	
Logging	87	
Standards	97	
E		
Editor		
How to: insert name	45	
Instrument control	45	
Instrument name	156	
EN 50564	96	
Enable registers		
Remote	186	
Error beep		
Setup	152	
Error value		
CSV settings	159	
Ethernet address		
How to: adjust IP address	177	
Evaluate measurement results		
Trying out	102	
Evaluating		
Logging	89	
Event status enable register (ESE)		
Remote	185	
Event status register (ESR)		
Remote	186	
Example		
Log file content	90	
External		
Analog input and output	128	
Digital input and output	130	
How to: configure analog input signal	128	
How to: configure analog output signal	129	
How to: configure digital input signal	130	
How to: configure digital output signal	131	
Input and output	127	
Limit position of parameter	130, 132	
External clamp-on current probe		
How to: configure measurement	136	
External measurement		
How to	52	
External probes		
How to: select measurement parameters	138	
External shunt		
How to: configure measurement	135	
F		
Fall back		
How to: set brightness	155	
Fallback time	42	
Field delimiter		
CSV settings	159	
Filename		
Logging	89	
Firmware		
Update	146	
Firmware update		
Access	147	
Notifications	248	
Frequency		
Standards	96	
Frequency filter		
Acquisition	69	
Front panel		
Connectors	33	
Display	31	
Keys	32	
Navigation controls	33	
Overview	30	
Function keys		
Overview	32	
Fuse holder		
AC power supply	36	
Fuses		
How to replace the line fuse	22	
G		
Gateway	174	
General functions		
Contrast	154	
Control beep	152	
CSV	157	
CSV settings	158	
Date	151	
Date and time	151	
Device information	149, 150	
Device name	156	
Display	152	
Display brightness	154	
Error beep	152	
Grid intensity	154	
Interface	149	
Key brightness	154, 156	
Key fallback time	156	
Power up	160	
Sound	151	
Time	151	
Update (firmware)	146	
General instrument functions	146	

General instrument settings		
CSV	159	
Default	161	
Power up	160	
General settings		
Miscellaneous	149	
Getting started	15	
GPIB		
Characteristics	166	
Settings	175	
GPIB address		
Adjusting	180	
GPIB address		
How to: adjust address	180	
Grid intensity		
General functions	153	
Setup	154	
Ground		
How to connect	23	
Ground terminal	36	
H		
HardCOPy subsystem		
Remote control commands	217	
Harmonics		
Display mode	110	
How to: configure view	111	
How to: Select specific harmonic	112	
How to: select tabular display	112	
Number	114	
Scaling	114	
Select view	113	
Source	113	
Subset	114	
Help	16	
High		
Limit	94	
How to		
External probe	134	
How to:		
Adjust Ethernet address	177	
Adjust interface addresses	177	
Adjust the GPIB bus address manually	180	
Assign IP address manually	177	
Automatic measurement range selection	57	
Check LAN connection	179	
Complete a measurement	102	
Configure analog input signal	128	
Configure analog output signal	129	
Configure digital input signal	130	
Configure digital output signal	131	
Configure inrush view	120	
Configure integrator duration mode	77	
Configure integrator external mode	78	
Configure integrator measurement manually	74	
Configure integrator span mode	76	
Configure logging	83	
Configure measurement with clamp-on current probe	136	
Configure measurement with external shunt	135	
Configure numeric view	109	
Configure standardized power measurement	98	
Configure trendchart view	117	
Configure waveform view	115	
Connect the DUT to the R&S NPA-Zx test adapter	28	
Connect to AC supply	24	
Connect to GPIB (IEC 625/IEEE 488)	177	
Connect to ground	23	
Connect USB storage device	26	
Connect to USB B	176	
Connecting to LAN	25	
Current acquisition settings	60	
Customize screen intensity	153	
Editor operation	45	
Enter data	44	
Evaluate inrush data	125	
Evaluate power measurement results	102	
Export measurement results	38	
Fall back time setting	155	
Firmware update	147	
Instrument name	156	
Key brightness setting	155	
Leave display mode	108	
Limit configuration	92	
Logging CSV data format	84	
Logging file settings	81	
Logging start	84	
Logging stop	85	
Manual measurement range selection	56	
Measure power characteristics	37	
Measure power consumption	98	
Mode acquisition settings	61	
Recall instrument settings	140	
Remove a settings file	140, 142	
Repeat a measurement	102	
Replace the line fuse	22	
Return to previous level or menu	150, 154, 156, 171, 176	
Revert to 230 V	23	
Save instrument settings	39, 140	
Save measurement results	38	
Save power measurement results	102	
Select harmonics tabular display	112	
Select integrator parameters	73	
Select logging parameters	81	
Select measurement parameters with external probes	138	
Select parameters for display	109	
Select specific harmonic	112	
Select the supplied mains voltage	23	
Select USB TMC	181	
Select USB VDC	181	
Setting date and time	29	
Setting harmonics display	111	
Setting up a current-based measurement	51	
Setting up a direct connection	51	
Setting up a voltage-based measurement	50	
Setting up an external measurement	52	
Start a measurement	37	
Start standardized power measurement	101	
Test setup with R&S NPA-Zx test adapter	27	
Voltage acquisition settings	60	
I		
Identification		
Remote	186	
IEC 61000-3-2	96	
IEC 62301	96	
Import log file		
Logging	90	
Initial instrument settings	29	

Input	
External mode	127, 139
Input analog	
Activate	129
Input connector	35
Input digital	
Activate	131
Invert	132
Mode	131
Inrush	
Acquisition time	124
Activate	124
CSV export	125
Display mode	119
How to: configure view	120
How to: evaluate data	125
Level	125
Settings	124
Slope	125
Trigger	124
Trigger level	125
Trigger slope	125
Visible	124
Instrument	
Carrying	18
Checking	18
Lifting	18
Operating site	18
Setting up	19
Tour	30
Unpacking	18
Instrument control	
Editors	45
Manual operation	40
Remote control	45
Ways of operation	40
Instrument functions	
Measurement parameters	54
Instrument name	
How to assign	156
Instrument security procedures	16
Instrument settings	
How to: recall settings	140
How to: remove a settings file	140, 142
How to: save settings	39, 140
Integrator	
Activate	78
Current time	79
Duration	80
Measurement mode	72
Mode	78
Range switch	80
Reset	79
Set date & time	80
Start	79
Start time	79
Stop	79
INTEgrator subsystem	
Remote control commands	218
Interactive softkeys	43
Front panel tour	32
Interface	
General functions	149
GPIB	166
LAN	164
USB	165
Interfaces	
Remote control	162
Interval	
Logging	86
Invert	
Digital input	132
Digital output	132
IP address	164
Adjusting	177
Dynamic	173
IP address Mode	173
IP adress	
How to: assign address manually	177
IP-Status	174
K	
Kensington lock	36
Key	
ACQ	32
Arrow	33
back	33
EXT	32
HELP	33
HOLD	32
I ▲, I ▼	32
MEAS	32
NULL	32
On/Standby	33
RESET	32
Rotary knob	33
SAVE/RECALL	33
SETUP	33
SHIFT	33
START/STOP	32
U ▲, U ▼	32
VIEW	32
Key brightness	
General functions	154
How to: set brightness	155
Setup	156
Key fallback time	
Setup	156
Key features	15
Keyboard	
On-screen	44
Keypad	
On-screen	44
Keys	
Front panel	32
L	
Lan	
Interface	164
LAN	
Characteristics	164
Connecting	24
How to connect	25
How to: check connection	179
IP address	164
LAN communication	
Problems	249
LAN connection	
Problems	249
Level	
Inrush view	125

- Lifting the instrument 18
- Limit
 - Activate 94
 - Analog output parameter 130
 - Digital output parameter 132
 - Measurement 91
 - Number of parameters 94
 - Parameter list 91
- Line separator
 - CSV settings 159
- Link 174
- Log page
 - Logging 86
- LOG subsystem
 - Remote control commands 223
- Logging 80
 - Accept storage settings 89
 - Activate 86
 - Browser 89
 - Change directory 88
 - Count 87
 - Create directory 89
 - CSV 89
 - Current time 87
 - Duration 87
 - Evaluating 89
 - Example 90
 - Filename 89
 - How to: configure logging 83
 - How to: data format settings 84
 - How to: file settings 81
 - How to: select parameters 81
 - How to: start 84
 - How to: stop 85
 - Import log file 90
 - Interval 86
 - Log page 86
 - Memory 88
 - Mode 86
 - Page 86
 - Remove directory 89
 - Set date & time 88
 - Settings 85
 - Start time 87
 - Storage 86, 88
 - Storage softkey menu 88
- Low
 - Limit 94
- M**
- Mac address 173
- Mains adapter 26
- Mains voltage
 - How to select the supplied mains voltage 23
 - Preparing 21
- Manual interaction 40
- Manual operation 40
- Measurement
 - Clamp-on probe 52
 - Current-based setup 50
 - Direct connection setup 51
 - How to: complete a measurement 102
 - How to: configure limits 92
 - How to: evaluate results 102
 - How to: repeat a measurement 102
 - How to: save results 102
 - Integrator 72
 - Limit 91
 - Limit high 94
 - Limit low 94
 - Limit number of parameters 94
 - Limit source 94
 - Limit state 94
 - Parameter list 54
 - Range 55
 - Setup 47
 - Shunt setup 52
 - Standards 95, 96
 - Voltage-based setup 49
- Measurement input
 - Connectors 33
- Measurement modes 72
- Measurement parameters 54
- Measurement range 55
 - About 55
 - How to: select automatically 57
 - How to: select manually 56
- Measurement results
 - How to: save and export 38
- Measurement start
 - How to: start with default settings 37
- Memory
 - Logging 88
- Messages 248
- Miscellaneous
 - Device name 157
 - General settings 149
- Mode
 - Acquisition 69
 - Analog output 129
 - Digital input 131
 - Digital output 132
 - Integrator 78
 - IP address 173
 - Logging 86
 - Sensor measurement 134
- Mode settings
 - Acquisition 68
- Mounting in a rack 20
- N**
- Navigation controls 43
 - Front panel tour 33
- Network
 - Settings 172
- Notifications 248
- Number
 - Harmonics view 114
- Numeric
 - Display mode 108
 - Page select 110
- Numeric data entry 44
- Numeric parameters 44
- Numeric view
 - How to: configure 109
- O**
- Open source acknowledgment (OSA) 17
- Operating site
 - Choosing 18

- Operation
 - Manually 40
 - Remotely 45
- Operation complete
 - Remote 186
- Operation status register 169
- Output
 - External mode 127, 139
- Output analog
 - Activate 129
 - Mode 129
- Output connector 35
- Output digital
 - Activate 131
 - Invert 132
 - Mode 132
- Overview
 - Front panel 30
 - Rear panel 34
- P**
- Page
 - Logging 86
 - Numeric view 110
- Parameter list
 - Limit 91
 - Measurement 54
 - Trendchart view 54
- Parameters
 - How to enter 44
- Pattern
 - Standards 97
- Peak hold
 - Reset 71
- Peak hold activate
 - Acquisition 70
- Peak hold settings
 - Acquisition 70
- Phase locked loop
 - Acquisition mode 69
- PLL source
 - Acquisition 69
- Power
 - Connecting the instrument 23
 - Standards 97
 - Waveform view 116
- Power characteristics
 - How to: measure 37
- Power consumption
 - How to: measure 98
- Power on
 - Key 33
- Power states 28, 29
- Power supply
 - Connector 36
 - Fuse holder 36
 - Switch 36
 - Voltage selector 36
- Power switch
 - AC power supply 36
- Power up
 - General functions 160
 - General instrument settings 160
- Preparing for use 18
- Product introduction 15
- Protocols
 - Remote control 162
- Q**
- Questionable status register 168
- R**
- Rack mounting 20
- Range
 - How to: select automatically 57
 - How to: select manually 56
 - Sensor measurement 133
 - Setting 55
- Range switch
 - Integrator 80
- Ratio
 - Sensor measurement 134
- Raw-port 174
- Readouts
 - Waveform view 116
- Rear panel
 - Connectors 35
 - Kensington lock 36
 - Overview 34
- Refresh
 - Acquisition 71
- Region
 - Standards 96
- Release notes 17
- Remote access 162
 - GPIB settings 175
 - IP address mode 173
 - IP-Status 174
 - Network gateway 174
 - Network IP address 173
 - Network Link 174
 - Network Mac address 173
 - Network raw-port 174
 - Network settings 172
 - Network transfer mode 174
 - Network VXI-11-port 174
 - Reset 175
 - Saves 175
 - Settings 170
 - Subnet mask 173
 - USB settings 171
- Remote control 45
 - Commands 184
 - Driver 17
 - General functions 149
 - GPIB interface 166
 - How to: adjust interface addresses 177
 - Interfaces 46, 162
 - LAN interface 164
 - Protocols 162
 - SCPI 162
 - Start 182
 - Stop 182
 - USB interface 165
- Remote control commands
 - CHANnel:ACQuisition subsystem 188
 - CHANnel:EXTERnal subsystem 197
 - CHANnel:LIMit subsystem 206
 - CHANnel:MEASurement subsystem 209
 - CHANnel:NAME subsystem 213

DATA subsystem	213
DISPlay subsystem	216
HardCOPy subsystem	217
INTEgrator subsystem	218
LOG subsystem	223
VIEW subsystem	236
Remote operation	
VNC	162
Remove directory	
Logging	89
Repeat a measurement	
Trying out	102
Replace the line fuse	
How to:	22
Reset	175
Integrator	79
Peak hold	71
Reset values	
Remote	187
Resistance	
Sensor measurement	134
Resource string	
VISA	164
Return	
How to: previous level or menu	150, 154, 156, 171, 176
Revert to 230 V	
How to:	23
Rotary knob	43
S	
Safety information	9
Safety instructions	10, 16
Save	
Input and output	139
Save measurement results	
Trying out	102
Saves	175
Scaling	
Harmonics view	114
SCPI	
Command description	184
SCPI programmers manual	
See user manual	16
Screen intensity	
General functions	153
Security procedures	16
Select parameters	
External measurement	138
Logging	81
Select parameters for display	
How to: select different from default	109
Select the supplied mains voltage	
How to:	23
Self-test	
Remote	188
Sensor	
Activate	133
Mode	134
Range	133
Ratio	134
Resistance	134
Settings	132
User	134
Service manual	16
Service request enable register (SRE)	
Remote	187
Set date & time	
Integrator	80
Logging	88
Setting up the instrument	
Considerations	21
Placing	19
Setting up the product	
Considerations	21
Settings	
Inrush view	124
Logging	85
Remote access	170
Sensor	132
Setup	
Brightness	154
Contrast	154
Control beep	152
Date	151
Device information	150
Error beep	152
Grid intensity	154
Key brightness	156
Key fallback time	156
Measurement	47
Sound	151
Time	151
Shunt	
Configuring	134
How to: configure measurement	135
Shunt measurement	
Setup	52
Signal words	13
Slope	
Inrush view	125
Socket	174
Sound	
Setup	151
Source	
Harmonics view	113
Limit	94
Trendchart view	118
Standardized power measurement	
How to: configure	98
How to: execute	101
Standards	
Class	97
Current crest factor	97
Current range	97
Cycle	97
Duration	97
Frequency	96
Measurement	96
Measurement mode	95
Pattern	97
Power	97
Region	96
Voltage	96
Standby	
Key	33
Start	
External measurement	138
Integrator	79
Logging	81
Start measurement	
Trying out	101

Start time		
Integrator	79	
Logging	87	
State		
Sensor measurement	133	
Status byte		
Remote	185, 187	
Status information		
Notifications	248	
Status reporting system	167	
Common commands	185	
Hierarchy of status registers	168	
Stop		
Integrator	79	
Storage		
Accept storage settings	89	
Change directory	88	
Create directory	89	
Logging	86, 88	
Remove directory	89	
Storage softkey menu		
Logging	88	
Store and recall	139	
Subnet mask	173	
Subset		
Harmonics view	114	
Switching		
Off	29	
On	28	
Switching on or off	28	
System and function keys	42	
System keys		
Overview	32	
T		
Table		
Harmonics view	113	
Test setup		
Mains adapter	26	
Test setup considerations		
Cable selection	21	
Voltage in/out	21	
Text entry	44	
Time		
General functions	151	
Setting	29	
Setup	151	
Time base		
Trendchart view	119	
Transfer	174	
Trendchart		
Clear	118	
Display mode	116	
How to: configure view	117	
Parameter list	54	
Source	118	
Time base	119	
Trigger		
Event (remote)	188	
Inrush view	124	
Trigger level		
Inrush view	125	
Trigger slope		
Inrush view	125	
Troubleshooting	248	
Firmware update notifications	248	
LAN communication problems	249	
LAN connection problems	249	
Status notifications	248	
Trying out	37	
Complete a measurement	102	
Configure measurement	98	
Evaluating measurement results	102	
Repeat a measurement	102	
Saving measurement results	102	
Starting a measurement	101	
Test setup	26	
Tutorials	16	
U		
Unpacking the instrument	18	
Update		
Firmware	146	
How to: update firmware	147	
USB		
Characteristics	165	
How to: select the VDC port	181	
How to: select TMC the port	181	
Settings	171	
USB a		
Connector	34	
USB B		
Connector	36	
How to: connect for remote control	176	
User		
Sensor measurement	134	
User manual	16	
V		
View		
Harmonics	110	
Inrush	119	
Numeric	108	
Select	113	
Trendchart	116	
Waveform	114	
VIEW subsystem		
Remote control commands	236	
VISA	163	
Resource string	164	
Visible		
Inrush view	124	
Voltage		
Input connector	33	
Standards	96	
Waveform view	116	
Voltage autorange		
Acquisition	66	
Voltage crest factor		
Acquisition	66	
Voltage in/out		
Test setup considerations	21	
Voltage invert		
Acquisition	66	
Voltage range		
Acquisition	66	
Voltage selector		
AC power supply	36	

Voltage settings	
Acquisition	65
Voltage-based measurement	
How to	50, 51
Setup	49
VXI-11 port	174

W

Wait	
Remote	188
Warning messages	
Signal words	13
Waveform	
Current	116
Display mode	114
How to: configure view	115
Power	116
Readouts	116
Voltage	116
Ways of operation	40
White papers	17